

Skimmer Lids 26 Link Drive YATALA QLD 4207				DO NOT SCALE DRAWING	REVISION
DRAWN	NAME	SIGNATURE	DATE	TITLE:	
	M.P.J.		18/10/2018		
CHK'D					
APPV'D					
MFG					
Q.A				DWG NO:	
				HAC 156 x 50 Mk2 kit	
				SCALE:2:3	A3
			WEIGHT:	SHEET 1 OF 3	

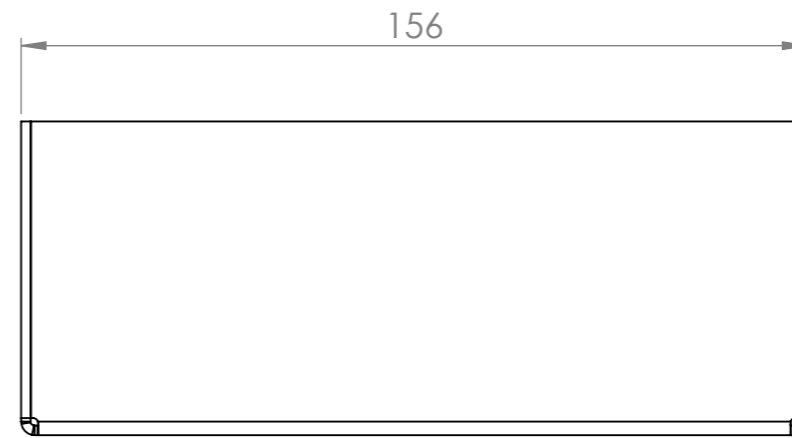

Skimmer Lids 26 Link Drive YATALA QLD 4207					DO NOT SCALE DRAWING	REVISION
DRAWN	NAME	SIGNATURE	DATE		TITLE:	
	M.P.J.		18/10/2018			
CHK'D						
APPV'D						
MFG						
Q.A				MATERIAL:	DWG NO:	HAC 156 x 50 Mk2 kit
				WEIGHT:	SCALE:2:3	
					SHEET 2 OF 3	

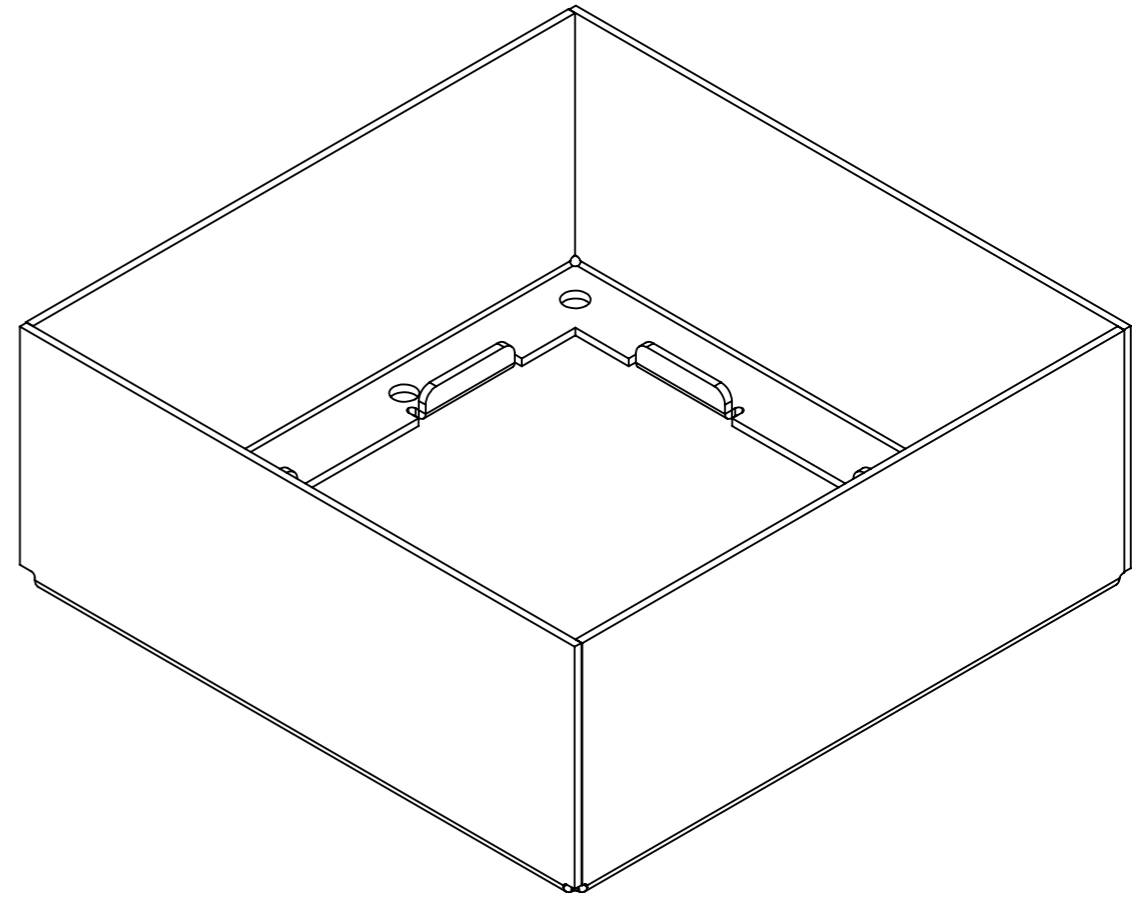
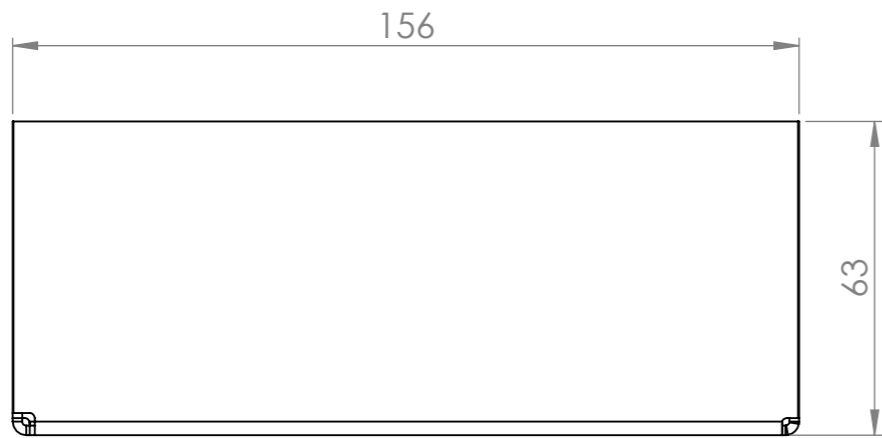
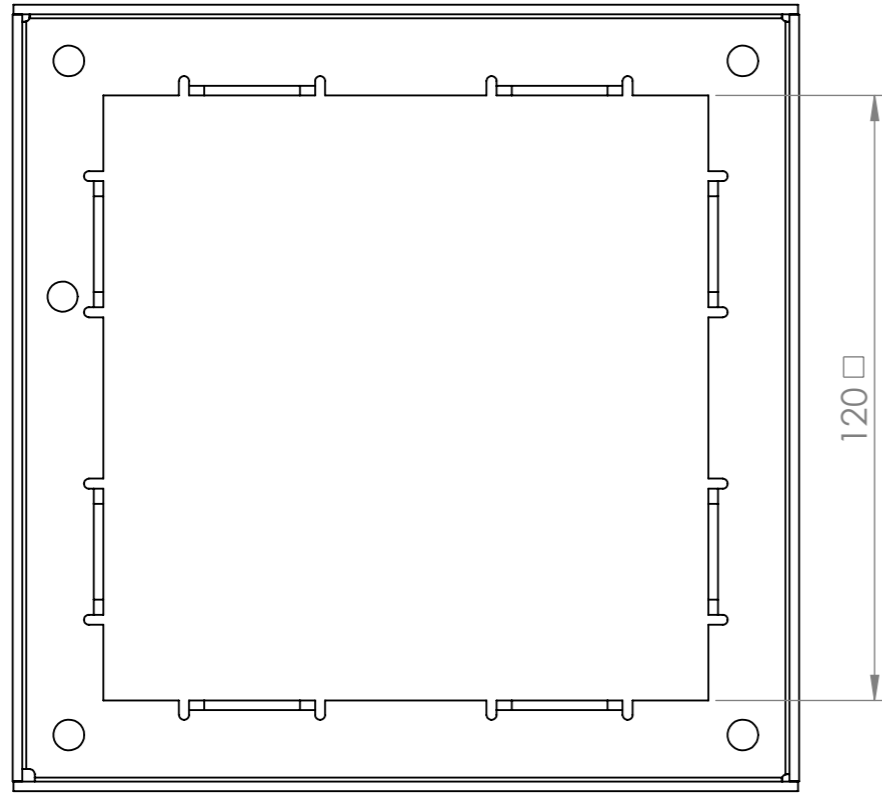
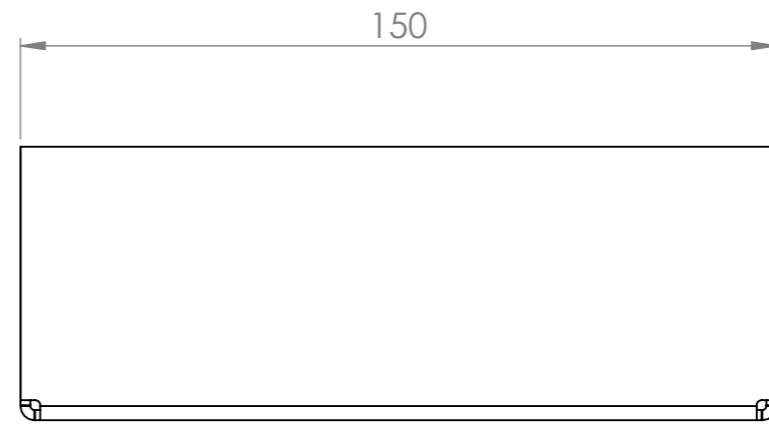
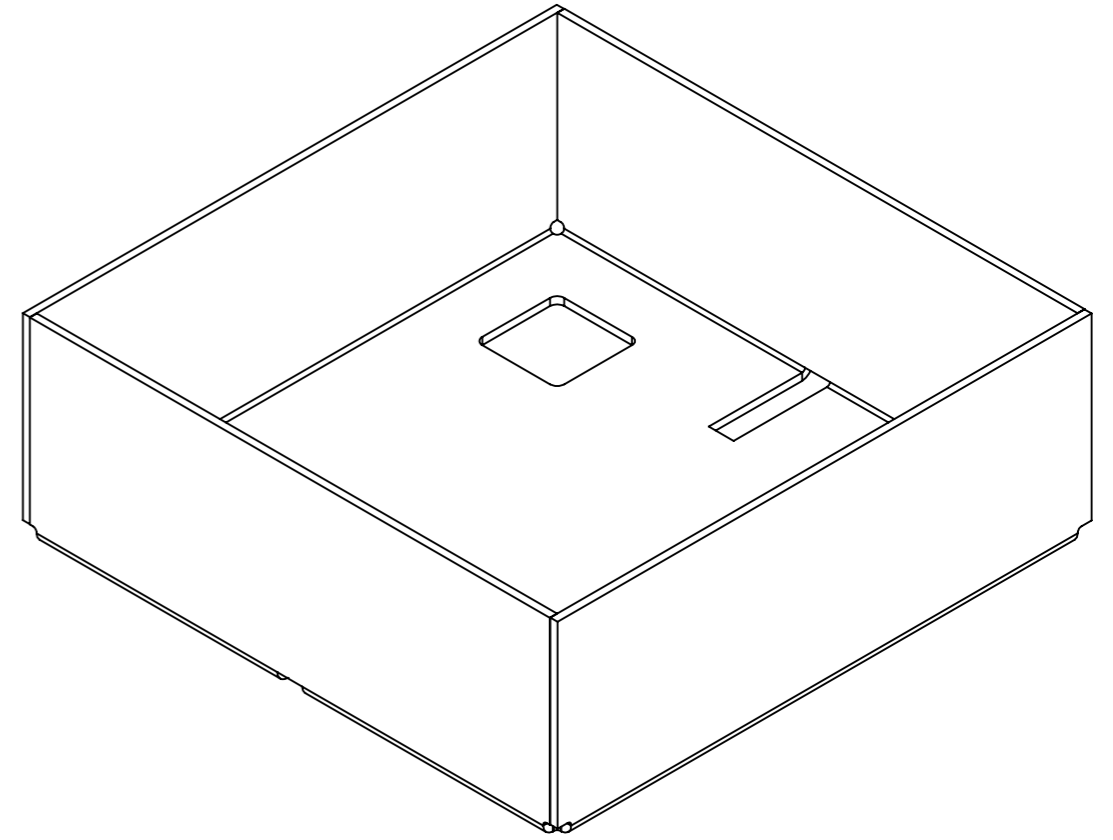
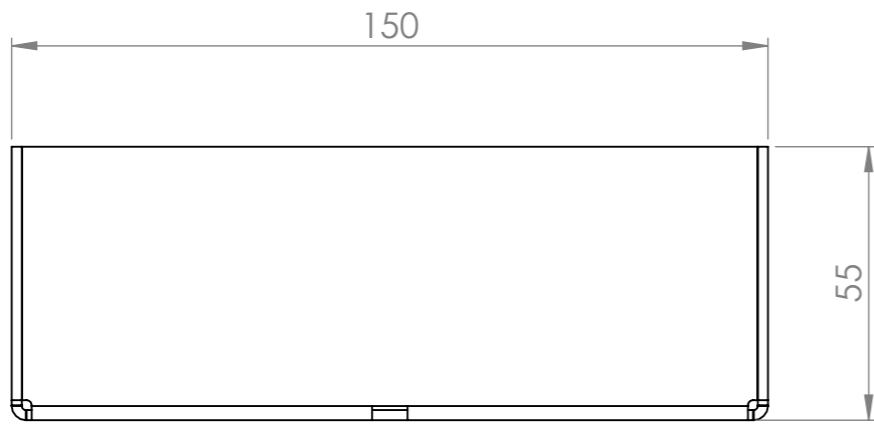
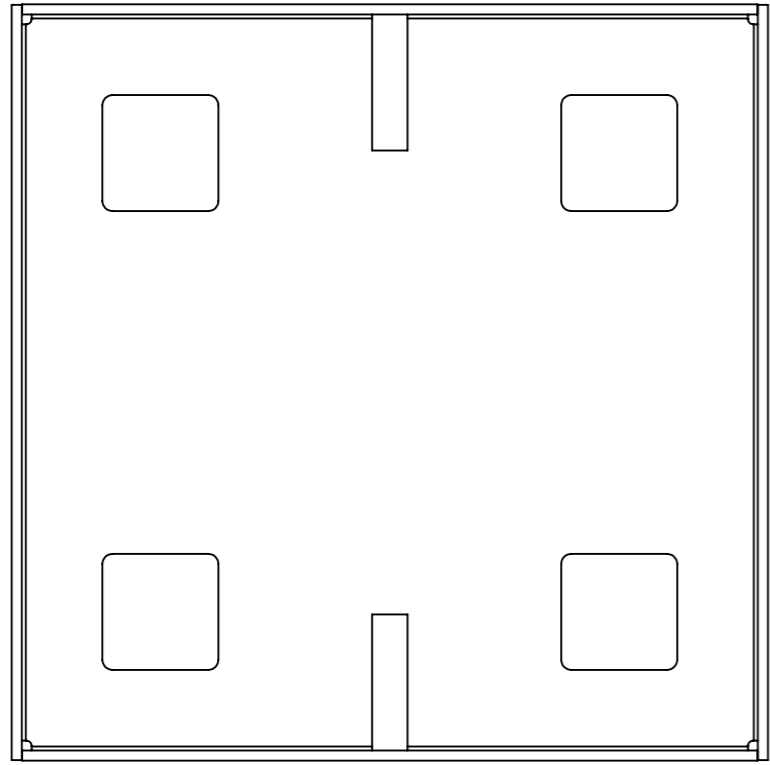

Skimmer Lids 26 Link Drive YATALA QLD 4207				DO NOT SCALE DRAWING		REVISION	
DRAWN	NAME	SIGNATURE	DATE		TITLE:		
	M.P.J.		18/10/2018				
CHK'D							
APPV'D							
MFG							
Q.A				MATERIAL:	DWG NO:	HAC 156 x 50 Mk2 kit	
						A3	
				WEIGHT:	SCALE:2:3	SHEET 3 OF 3	