

Skimmer Lids 26 Link Drive YATALA QLD 4207				DO NOT SCALE DRAWING		REVISION
				TITLE:		
DRAWN	NAME	SIGNATURE	DATE	MATERIAL:		
	M.P.J.		4/10/2024	DWG NO. 256 x 30 Mk4 kit		
CHK'D				A3		
APPV'D				SCALE:1:3		
MFG				SHEET 1 OF 3		
Q.A				WEIGHT:		

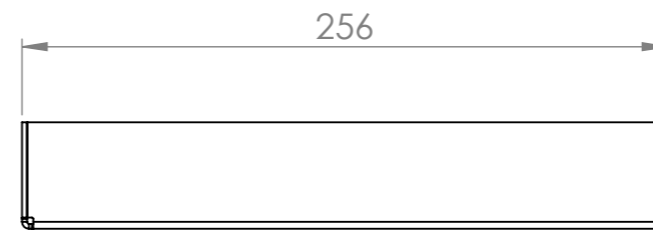

Skimmer Lids 26 Link Drive YATALA QLD 4207				DO NOT SCALE DRAWING	REVISION
	NAME	SIGNATURE	DATE	TITLE:	
DRAWN	M.P.J.		4/10/2024		
CHK'D					
APPV'D					
MFG					
Q.A				MATERIAL:	DWG NO. <b>256 x 30 Mk4 kit</b>
				WEIGHT:	A3
				SCALE:1:3	SHEET 2 OF 3

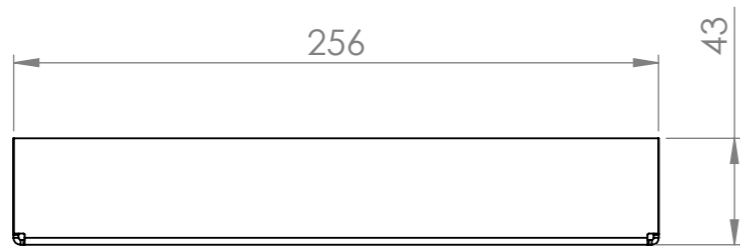
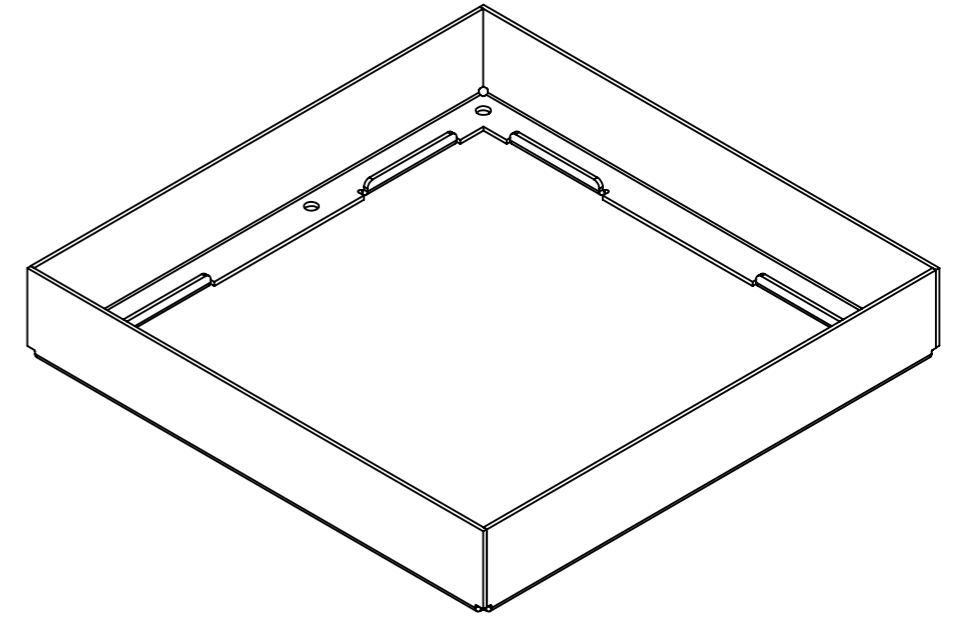
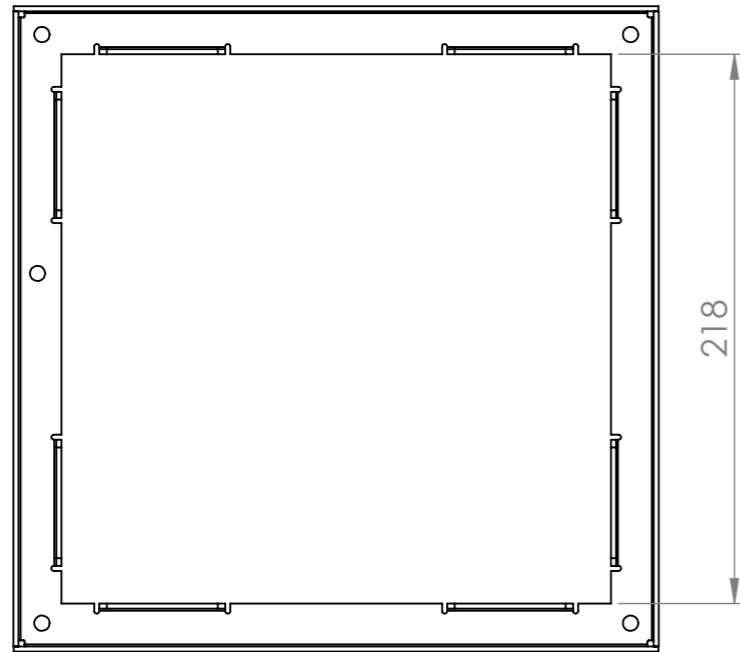
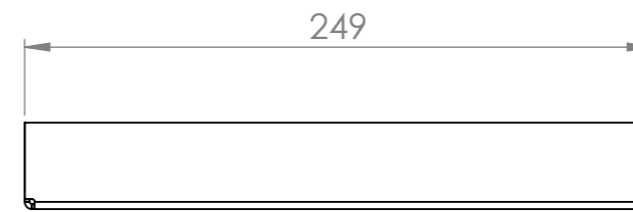
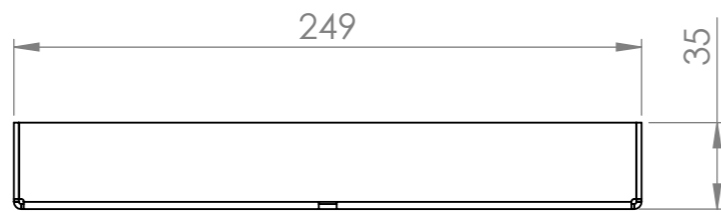
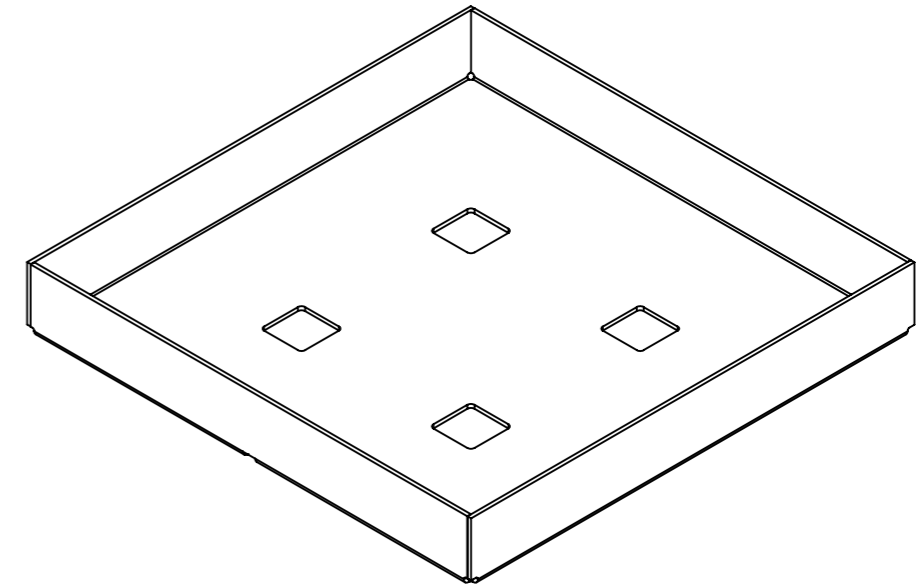
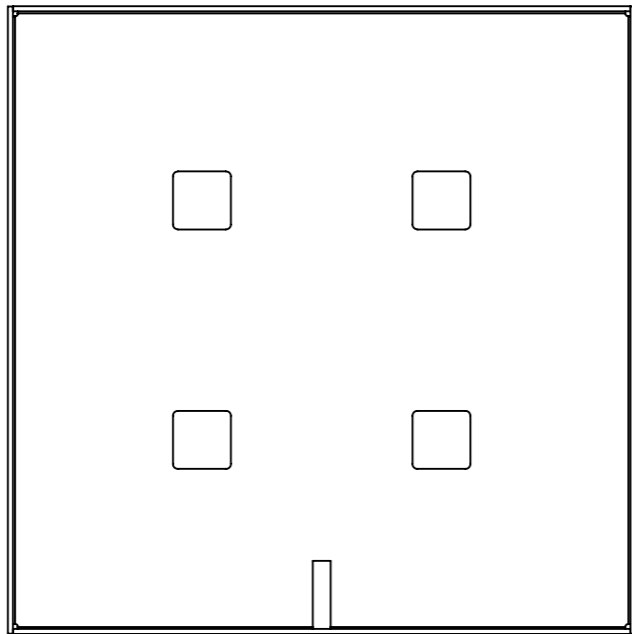

Skimmer Lids 26 Link Drive YATALA QLD 4207				DO NOT SCALE DRAWING		REVISION	
	NAME	SIGNATURE	DATE		TITLE:		
DRAWN	M.P.J.		4/10/2024				
CHK'D							
APPV'D							
MFG							
Q.A				MATERIAL:	DWG NO. 256 x 30 Mk4 kit		A3
				WEIGHT:	SCALE:1:3	SHEET 3 OF 3	