

Skimmer Lids 26 Link Drive YATALA QLD 4207				DO NOT SCALE DRAWING		REVISION
				TITLE:		
DRAWN	NAME	SIGNATURE	DATE	MATERIAL:		
CHK'D	M.P.J.		4/10/2024	DWG NO. HAC 656 x 20 kit		
APPV'D				A3		
MFG				SCALE:1:5		
Q.A				SHEET 1 OF 3		
				WEIGHT:		

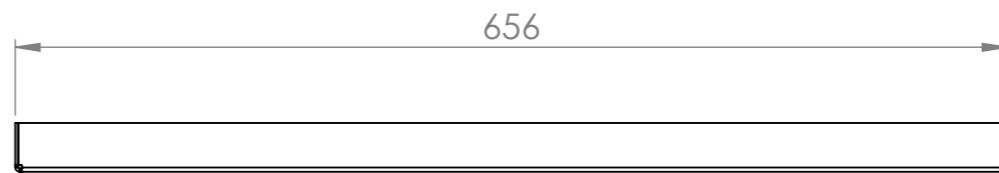

Skimmer Lids 26 Link Drive YATALA QLD 4207				DO NOT SCALE DRAWING		REVISION	
DRAWN	NAME	SIGNATURE	DATE	TITLE:			
	M.P.J.		4/10/2024				
CHK'D							
APPV'D							
MFG							
Q.A				MATERIAL:		DWG NO. HAC 656 x 20 kit	
						A3	
				WEIGHT:		SCALE:1:5	
						SHEET 2 OF 3	

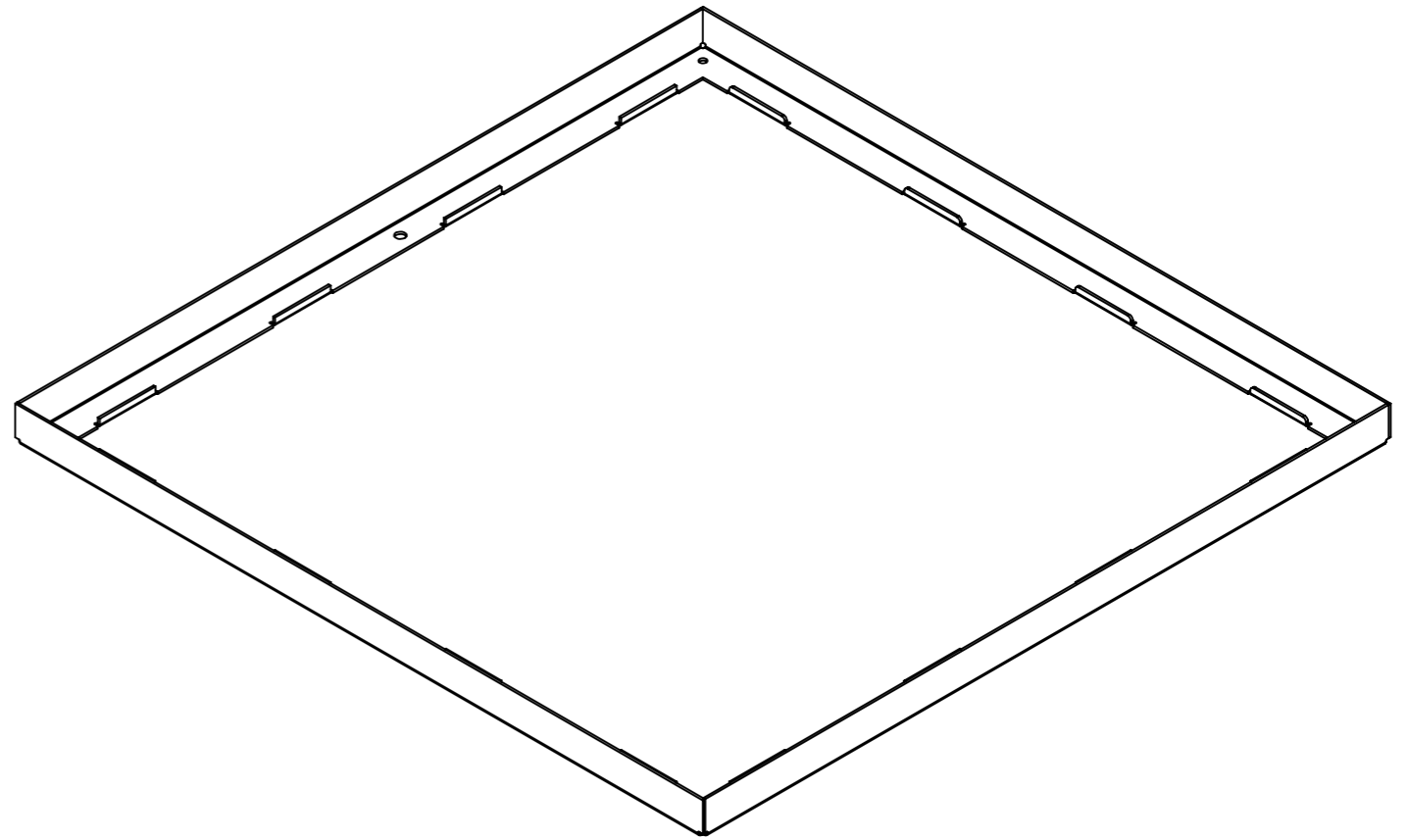
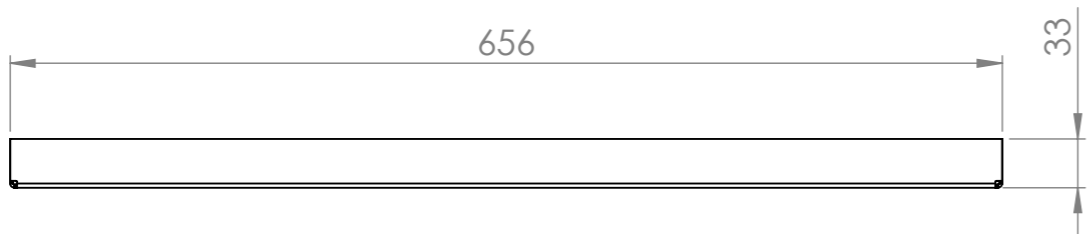
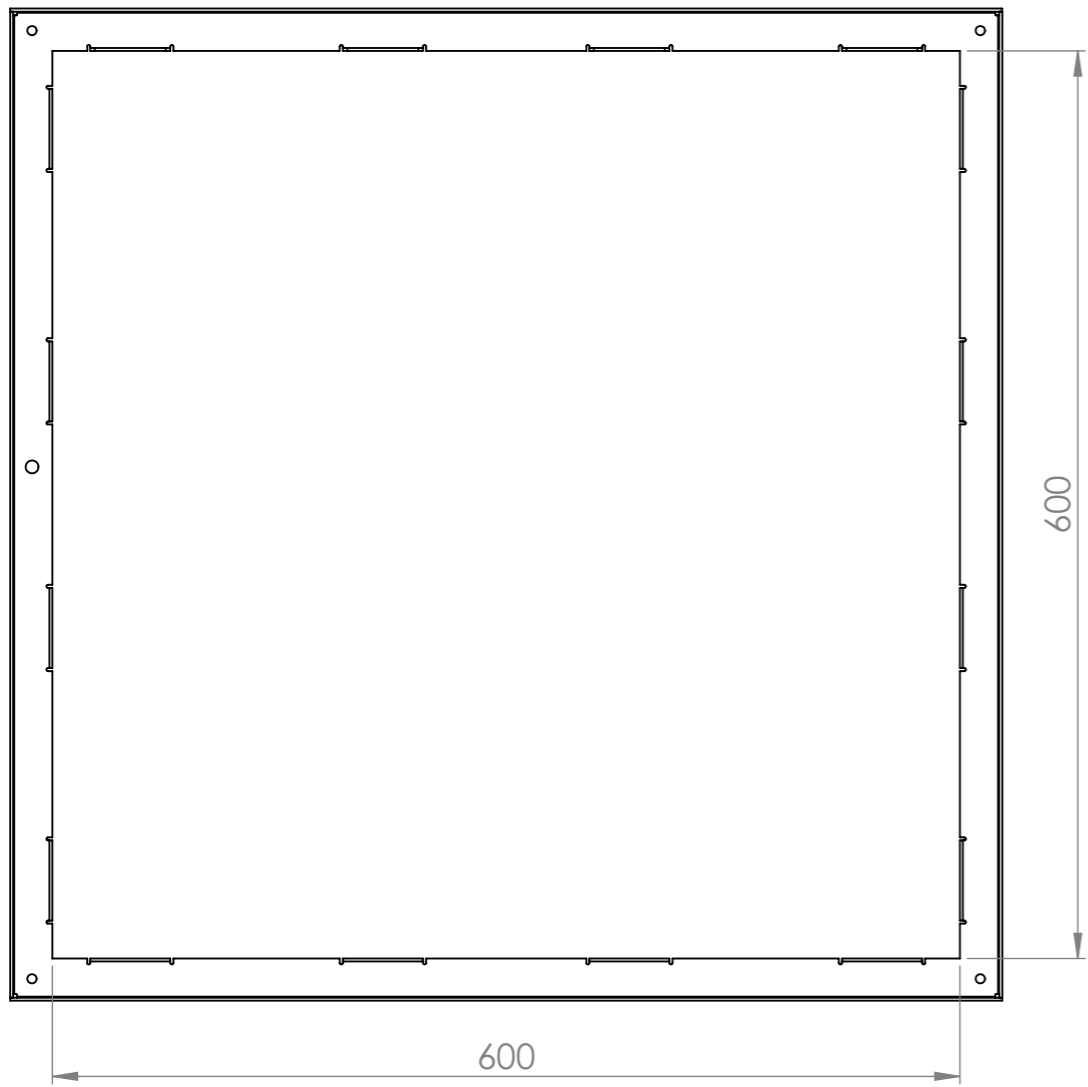
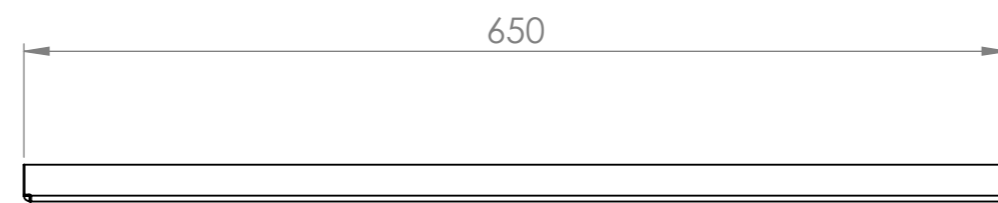
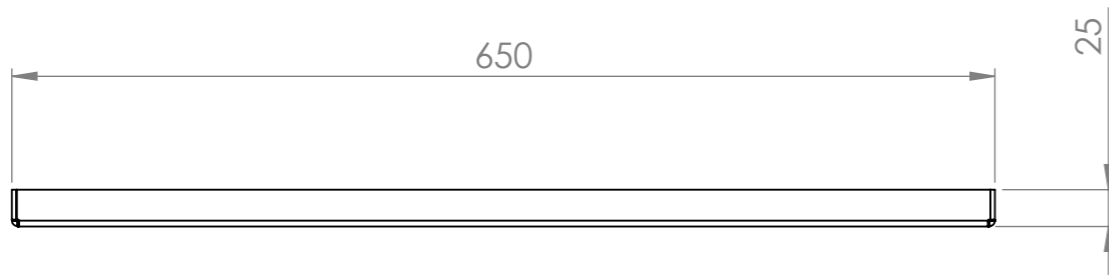
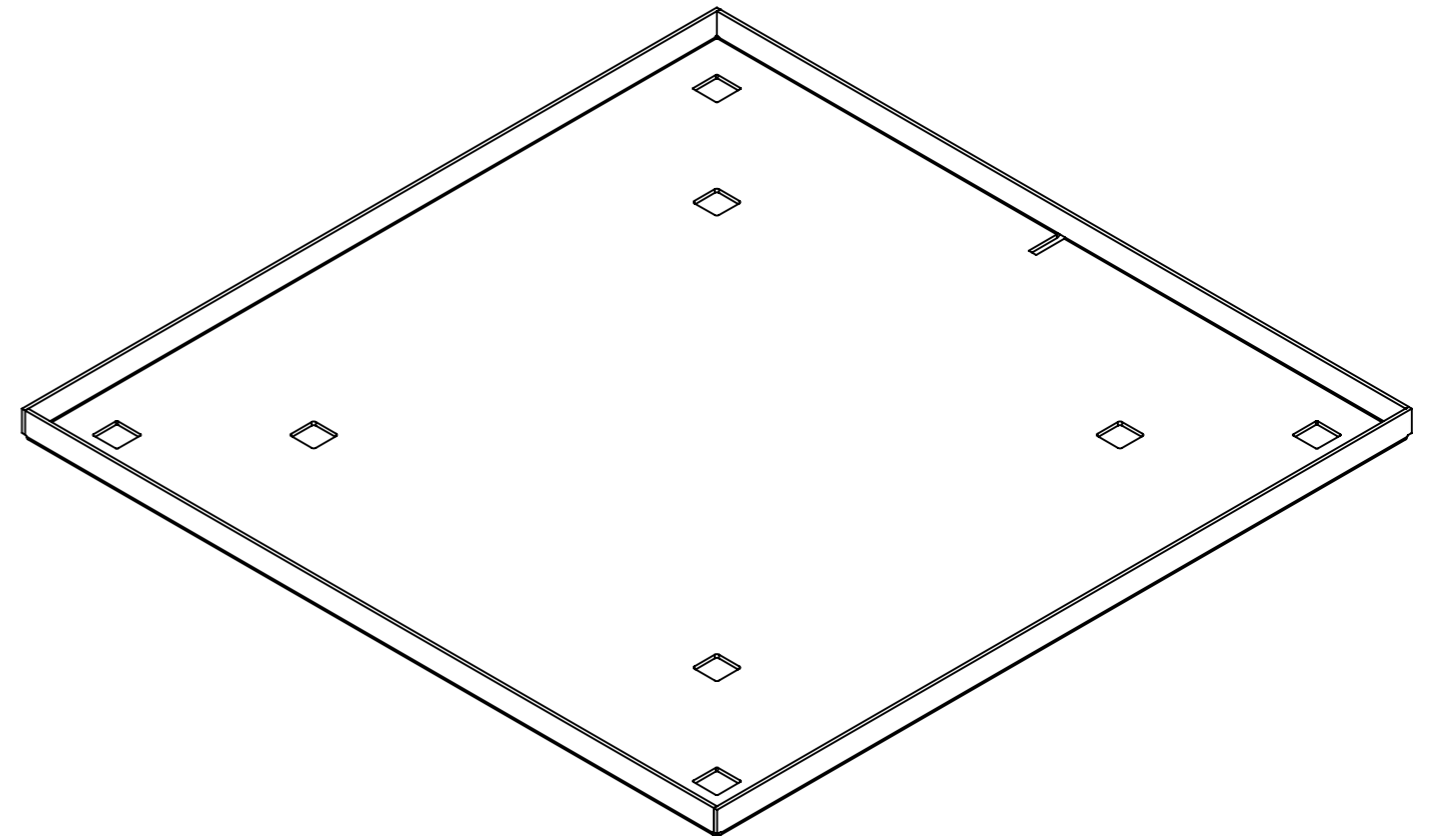
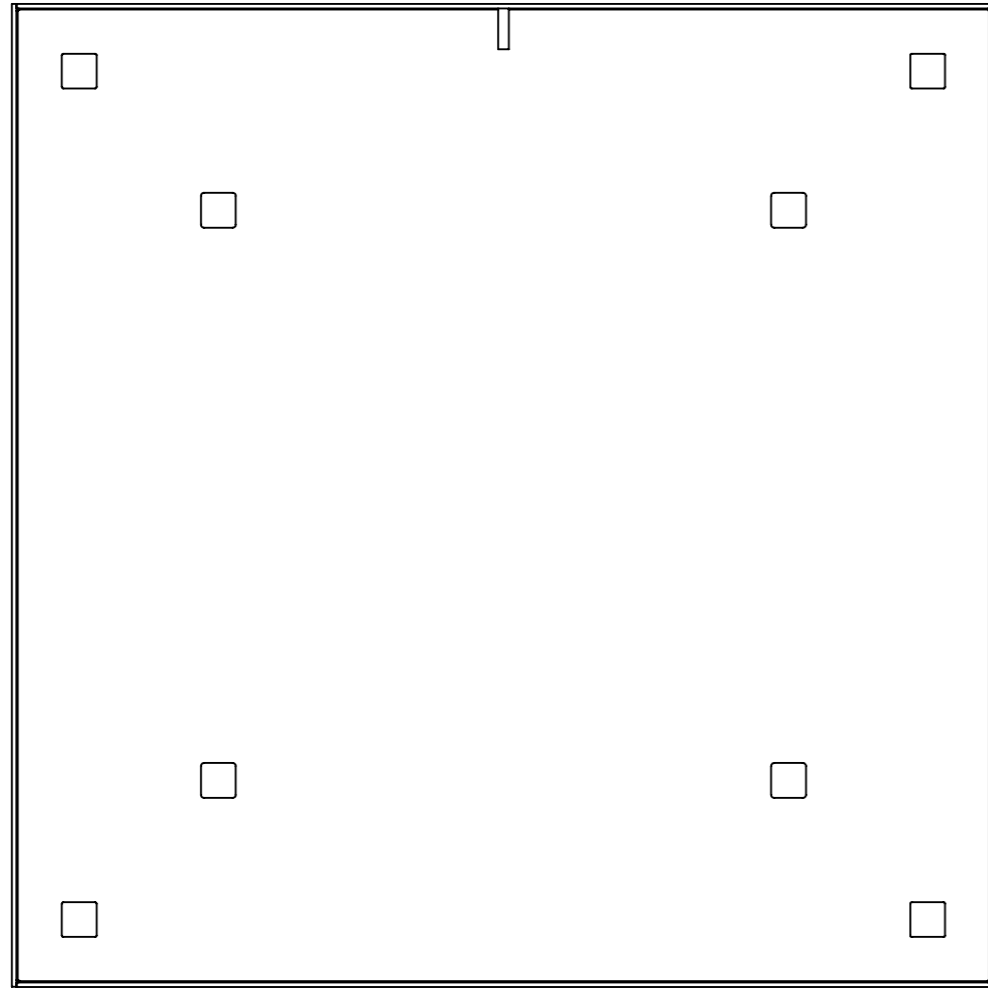

Skimmer Lids 26 Link Drive YATALA QLD 4207				DO NOT SCALE DRAWING		REVISION	
DRAWN	NAME	SIGNATURE	DATE	TITLE:			
	M.P.J.		4/10/2024				
CHK'D							
APPV'D							
MFG							
Q.A				MATERIAL:	DWG NO. HAC 656 x 20 kit		A3
				WEIGHT:	SCALE:1:5	SHEET 3 OF 3	