

Skimmer Lids 26 Link Drive YATALA QLD 4207				DO NOT SCALE DRAWING		REVISION
				TITLE:		
DRAWN	NAME	SIGNATURE	DATE	MATERIAL:		
CHK'D	M.P.J.		4/07/2025	DWG NO. HAC 656 x 30 kit		
APPV'D				A3		
MFG				SCALE:1:5		
Q.A				SHEET 1 OF 3		
				WEIGHT:		

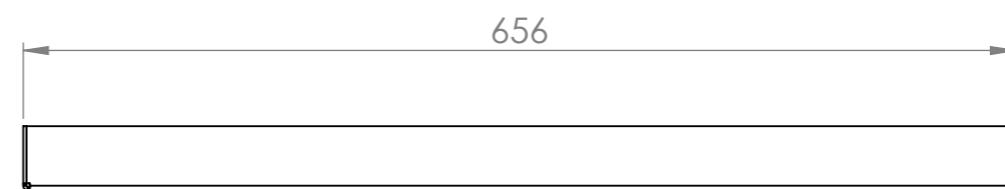

Skimmer Lids 26 Link Drive YATALA QLD 4207				DO NOT SCALE DRAWING		REVISION	
	NAME	SIGNATURE	DATE		TITLE:		
DRAWN	M.P.J.		4/07/2025				
CHK'D							
APPV'D							
MFG							
Q.A				MATERIAL:	DWG NO. HAC 656 x 30 kit		A3
				WEIGHT:	SCALE:1:5	SHEET 2 OF 3	

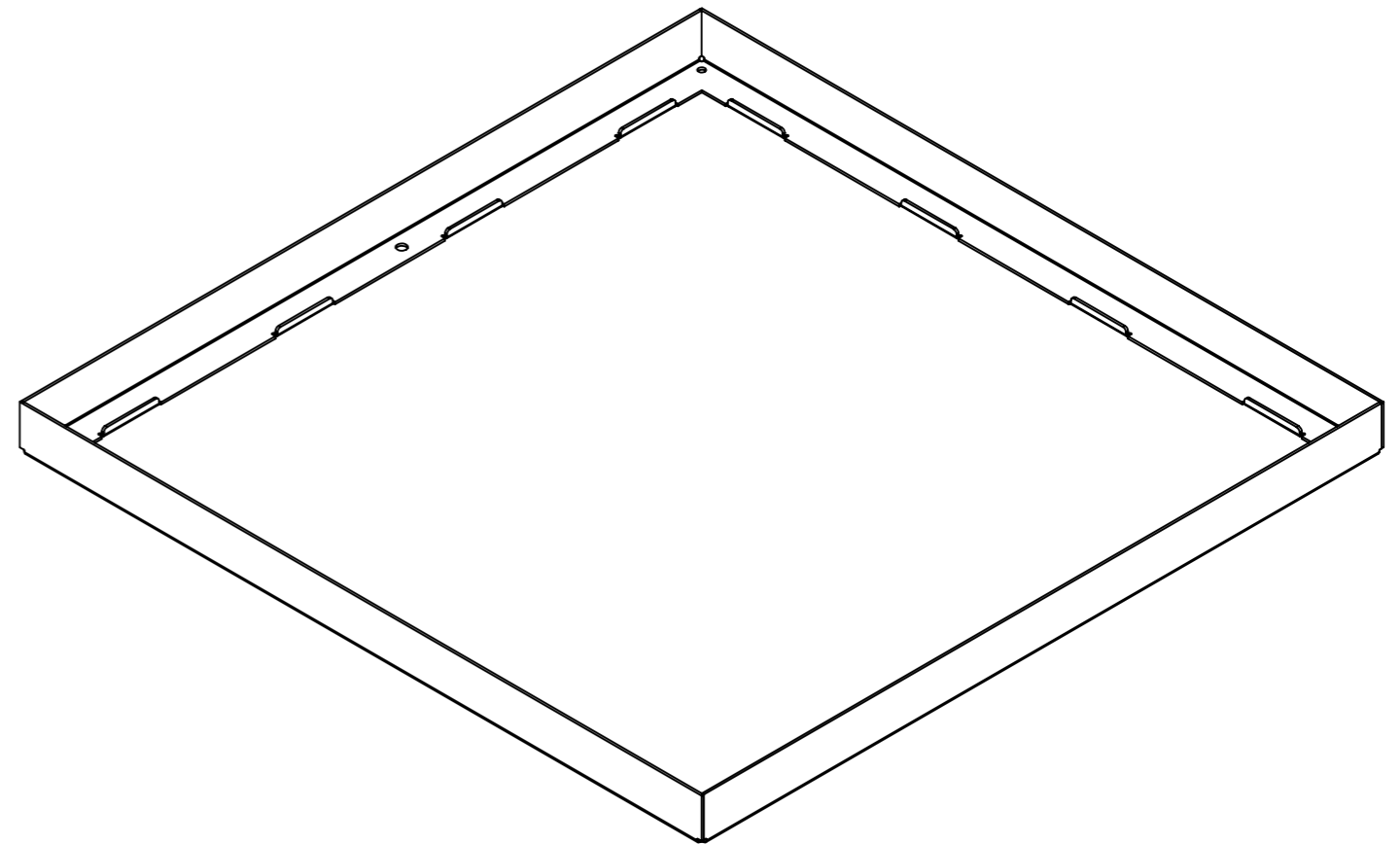
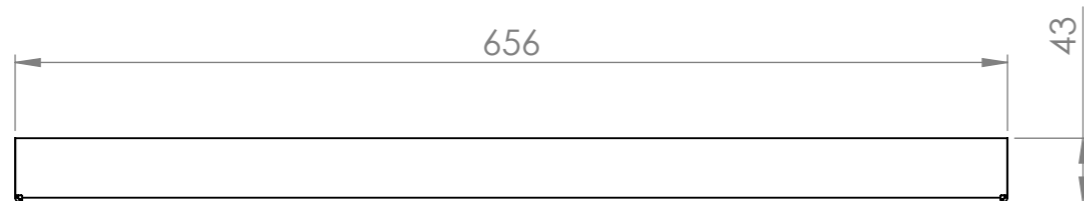
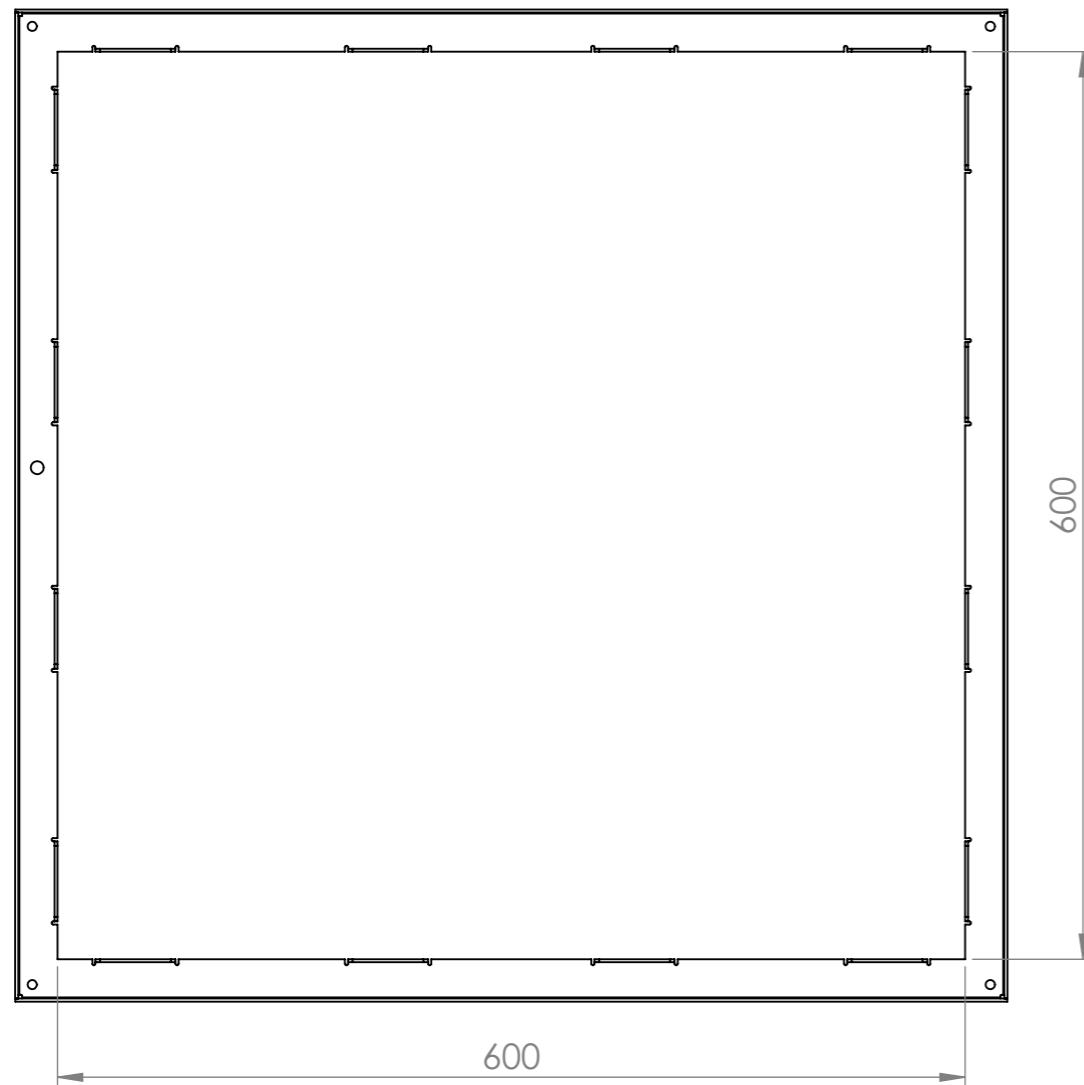
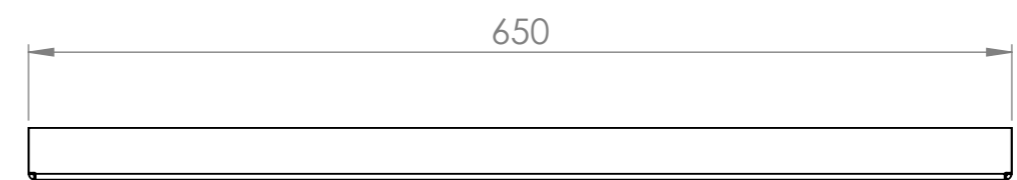
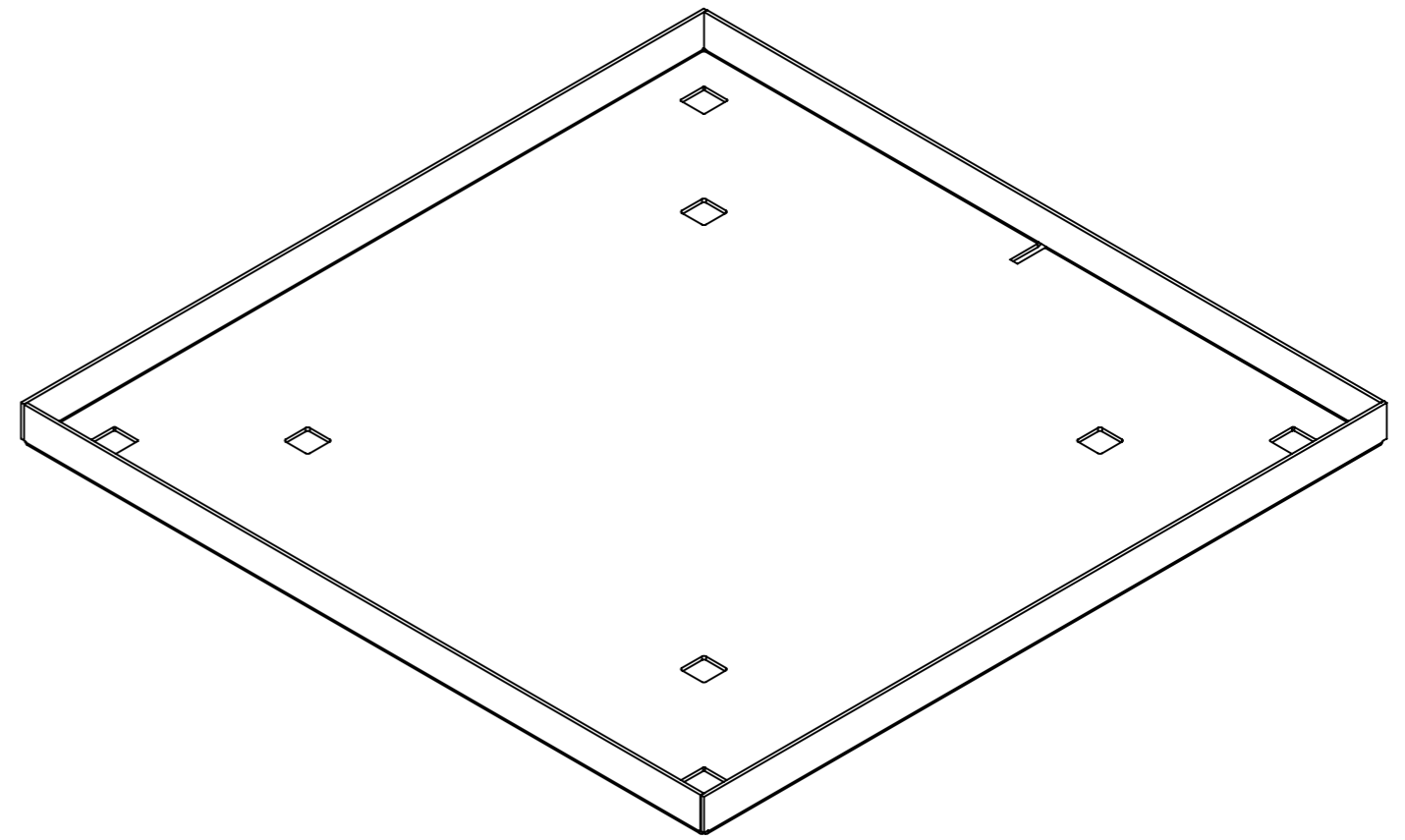
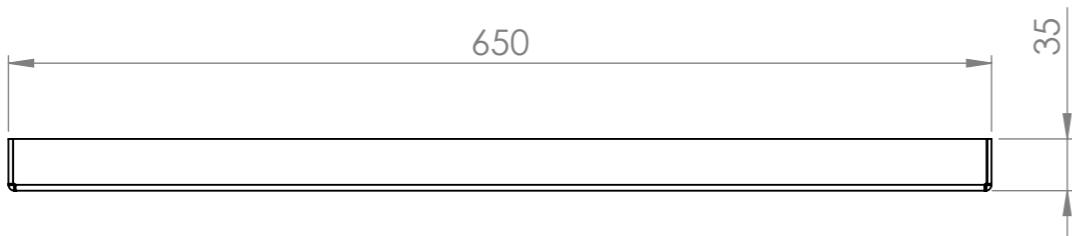
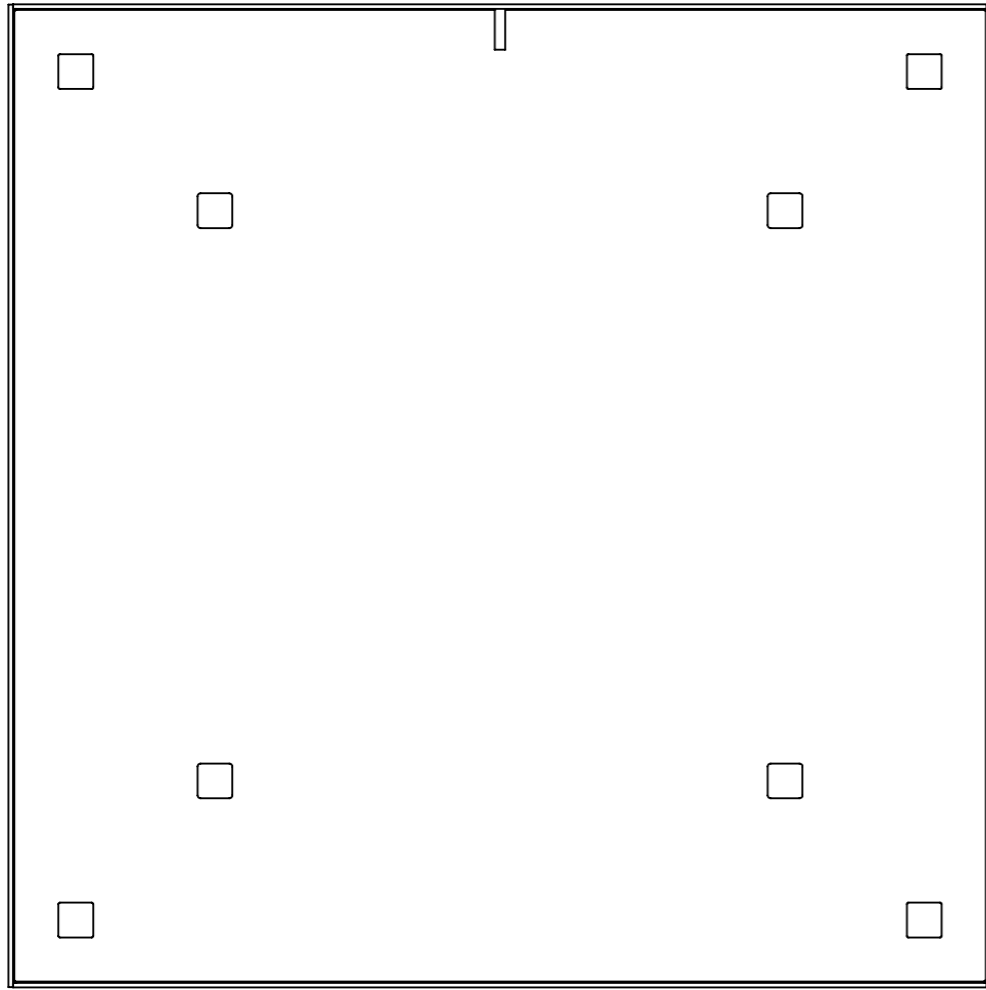

Skimmer Lids 26 Link Drive YATALA QLD 4207				DO NOT SCALE DRAWING	REVISION
DRAWN	NAME	SIGNATURE	DATE	TITLE:	
	M.P.J.		4/07/2025		
CHK'D					
APPV'D					
MFG					
Q.A			MATERIAL:	DWG NO.	HAC 656 x 30 kit
			WEIGHT:	SCALE:1:5	SHEET 3 OF 3
					A3