

Skimmer Lids 26 Link Drive YATALA QLD 4207				DO NOT SCALE DRAWING		REVISION	
	NAME	SIGNATURE	DATE		TITLE:		
DRAWN	M.P.J.		14/04/2025				
CHK'D							
APPV'D							
MFG							
Q.A				MATERIAL:	DWG NO.		A3
					HDC 342 x 30		
				WEIGHT:	SCALE:1:3	SHEET 1 OF 3	

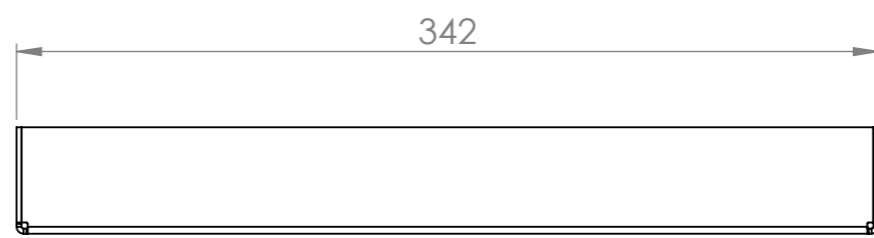

<p style="text-align: center;">Skimmer Lids 26 Link Drive YATALA QLD 4207</p>				DO NOT SCALE DRAWING		REVISION
				TITLE:		
DRAWN	NAME	SIGNATURE	DATE	MATERIAL:		SCALE:1:3
CHK'D	M.P.J.		14/04/2025			SHEET 2 OF 3
APPV'D				WEIGHT:		
MFG						
Q.A						

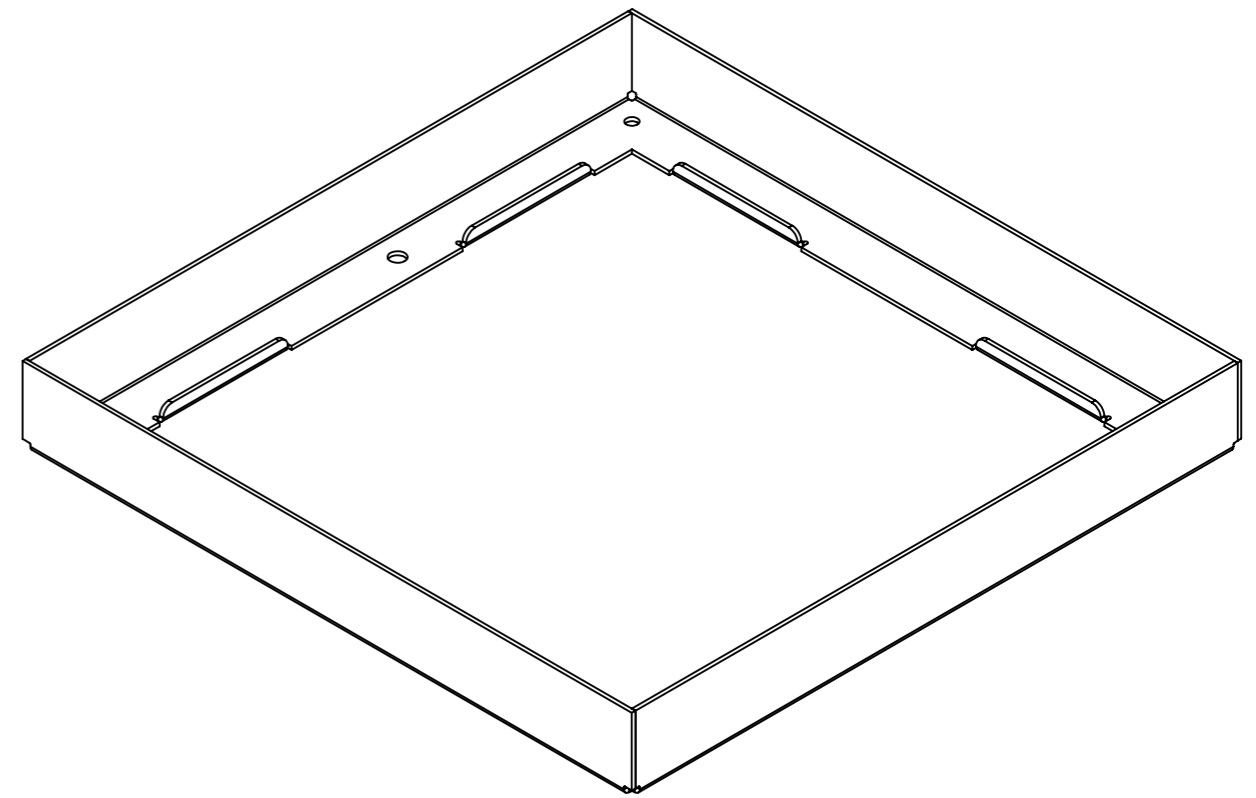
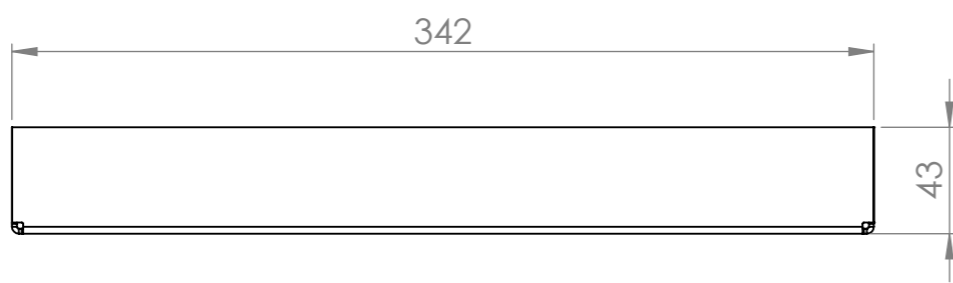
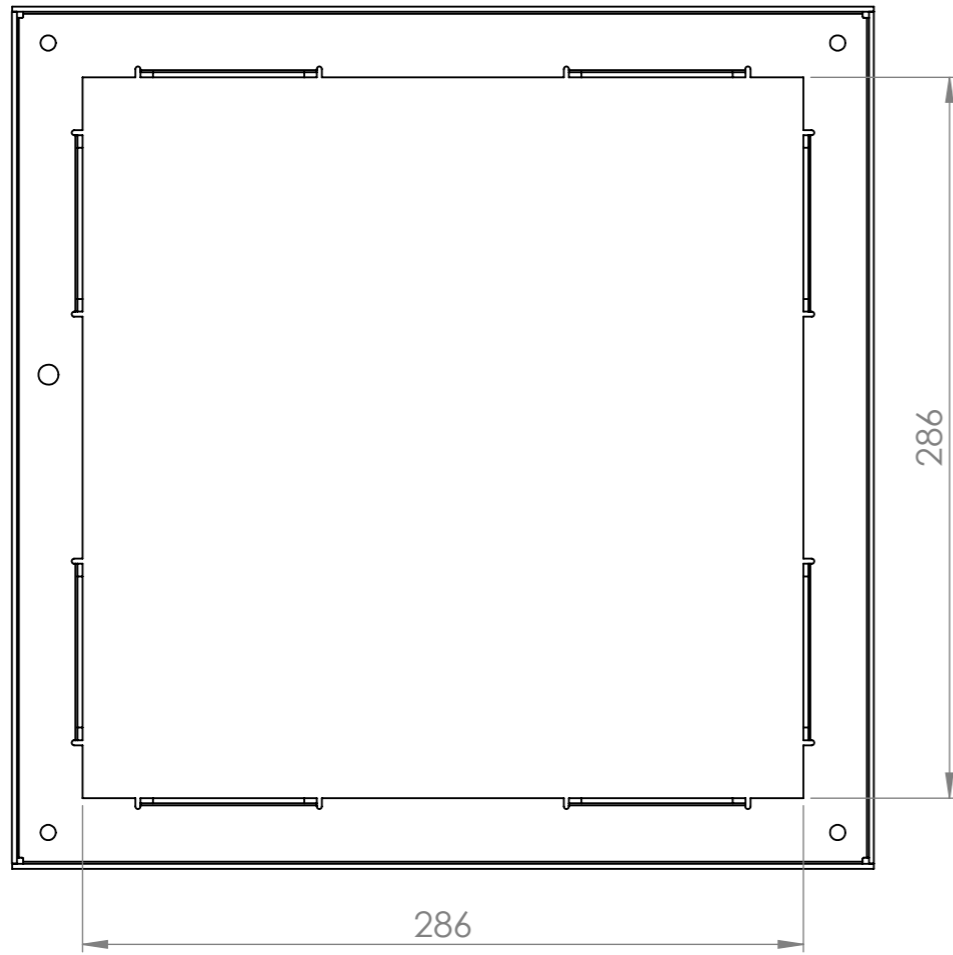
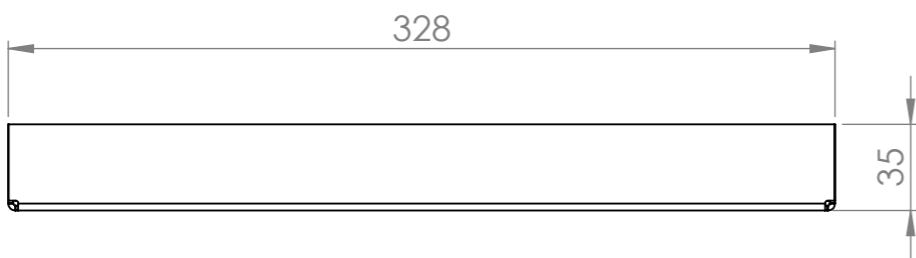
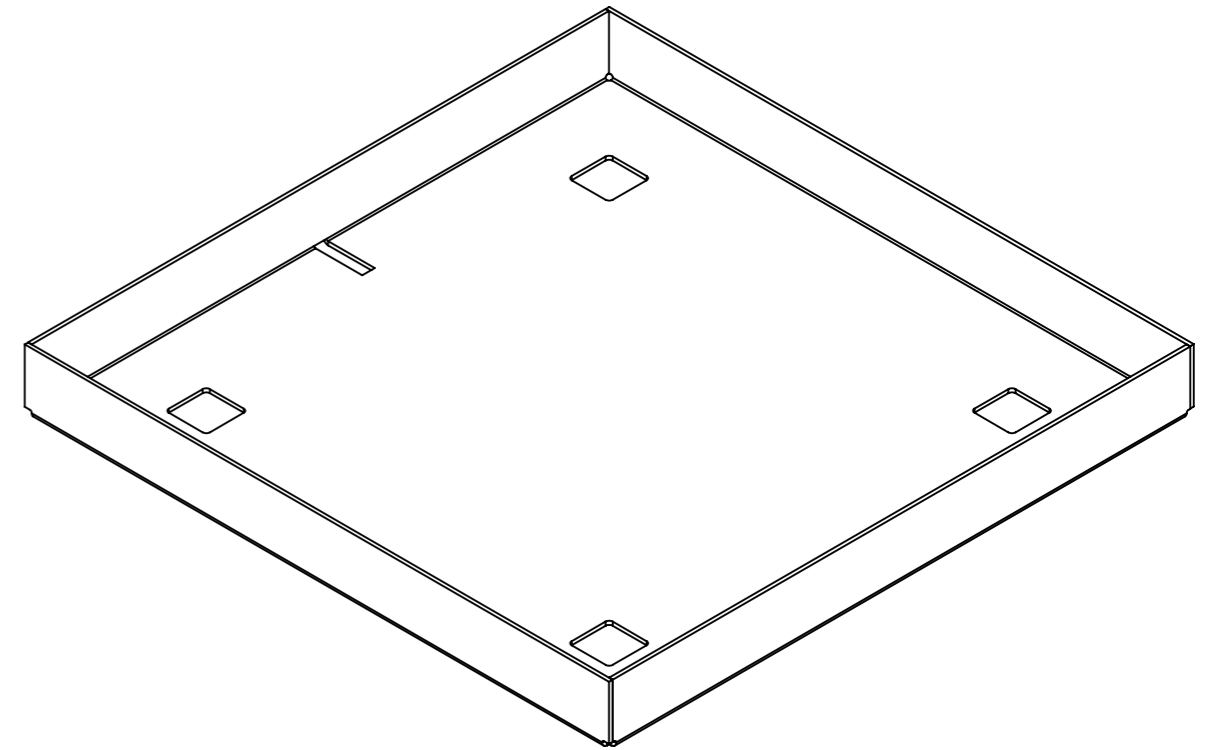
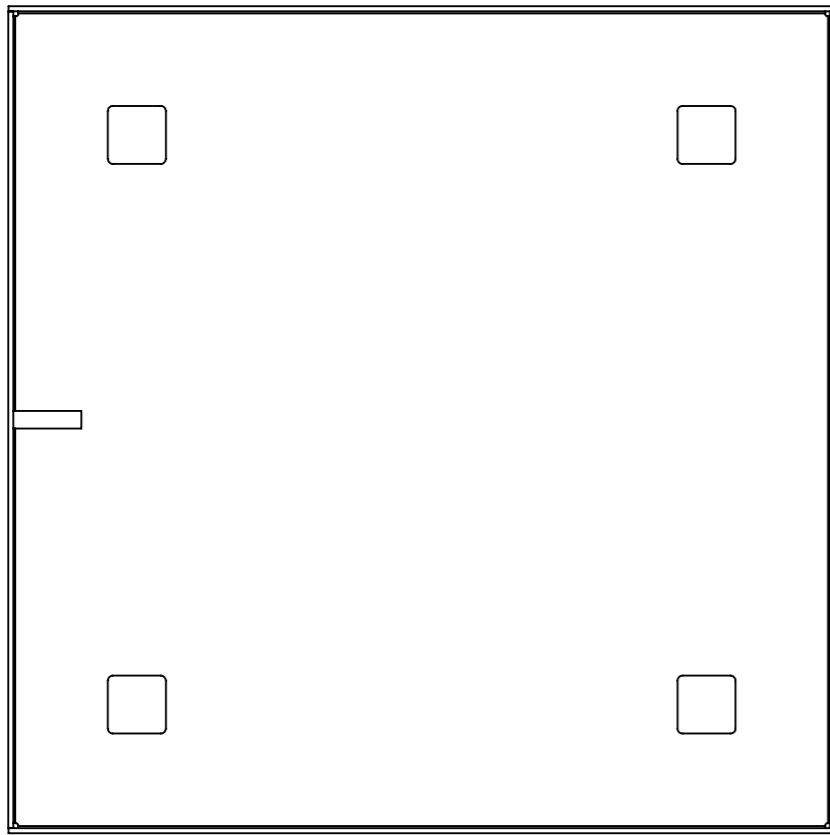

Skimmer Lids 26 Link Drive YATALA QLD 4207				DO NOT SCALE DRAWING		REVISION	
	NAME	SIGNATURE	DATE		TITLE:		
DRAWN	M.P.J.		14/04/2025				
CHK'D							
APPV'D							
MFG							
Q.A				MATERIAL:	DWG NO.	HDC 342 x 30	A3
				WEIGHT:	SCALE:1:3	SHEET 3 OF 3	