

Skimmer Lids Unit 3 / 26 Octal Street, YATALA QLD 4207				DEBUR AND BREAK SHARP EDGES	DO NOT SCALE DRAWING	REVISION
					TITLE:	
DRAWN	NAME	SIGNATURE	DATE			
	M.P.J.		16/10/2019			
CHK'D						
APPV'D						
MFG						
Q.A				MATERIAL:	DWG NO.	
				3mm Aluminium	306 x 10 kit	A3
				WEIGHT:	SCALE:1:4	SHEET 1 OF 3

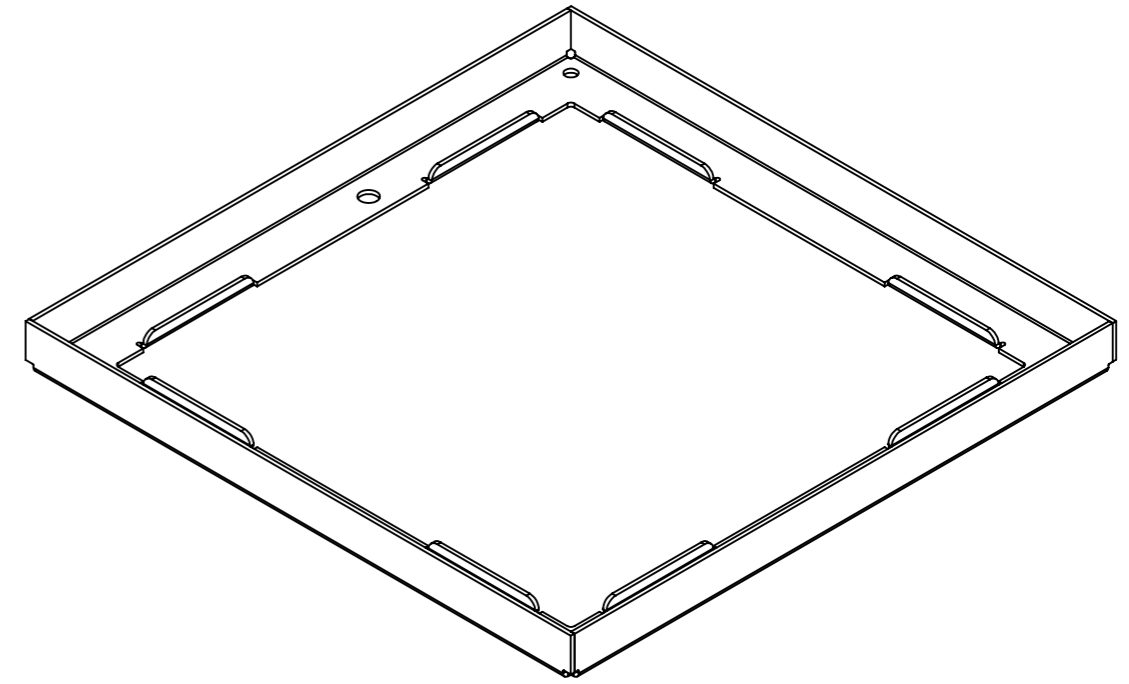

Skimmer Lids Unit 3 / 26 Octal Street, YATALA QLD 4207				DEBUR AND BREAK SHARP EDGES	DO NOT SCALE DRAWING	REVISION
DRAWN	NAME	SIGNATURE	DATE		TITLE:	
	M.P.J.		16/10/2019			
CHK'D						
APPV'D						
MFG						
Q.A				MATERIAL:	DWG NO.	
				3mm Aluminium	306 x 10 kit	A3
				WEIGHT:	SCALE:1:3	SHEET 2 OF 3

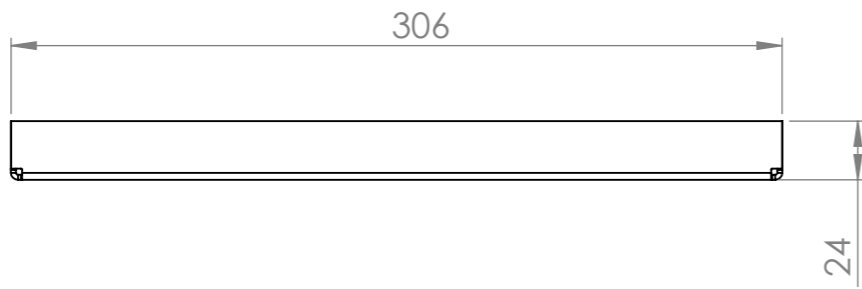
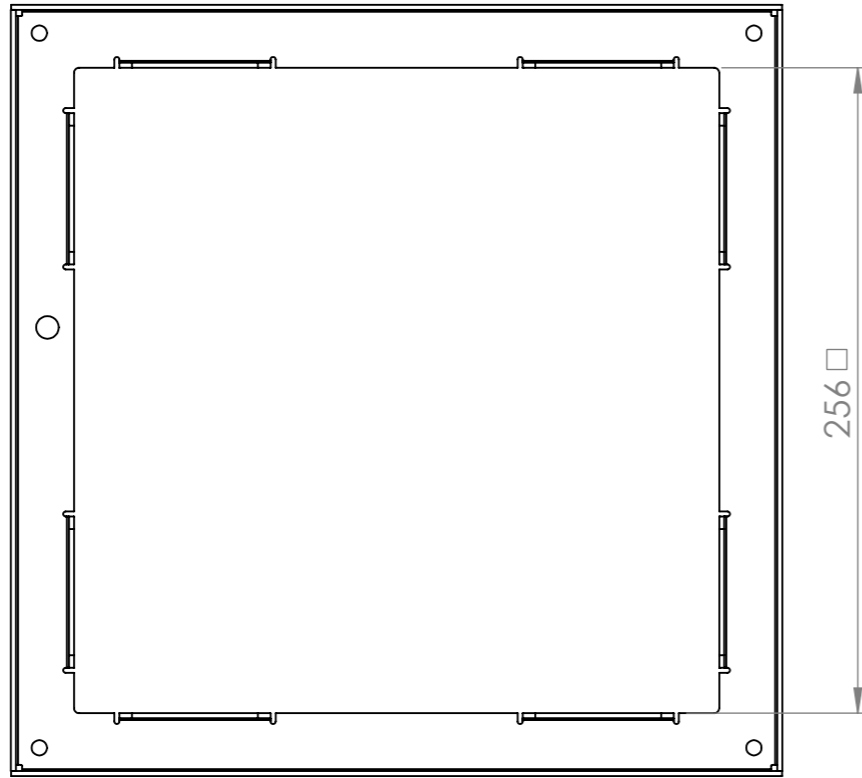
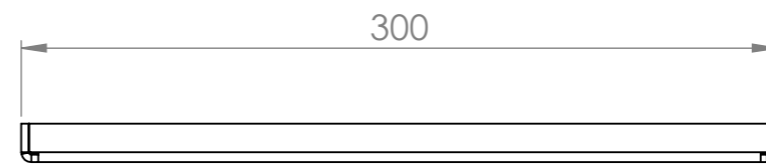
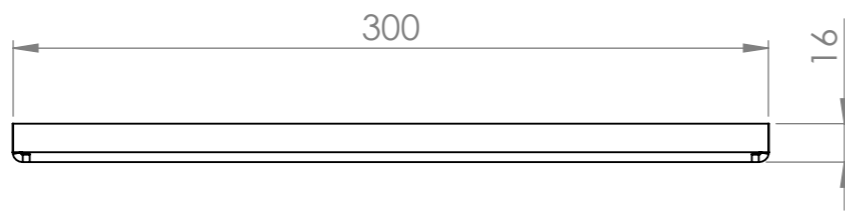
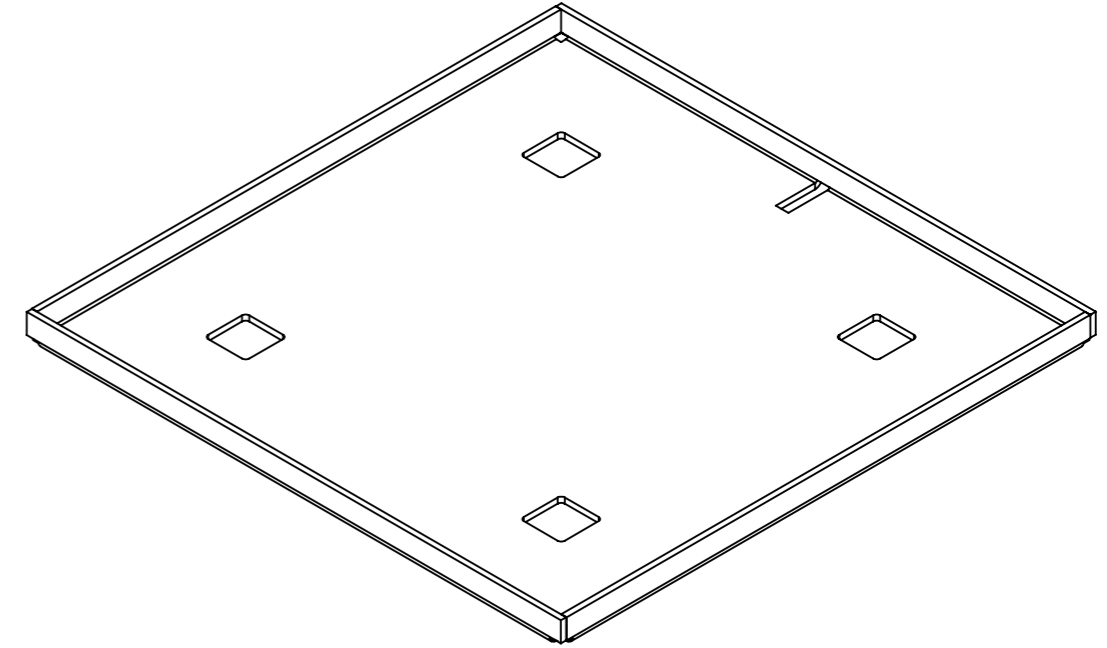
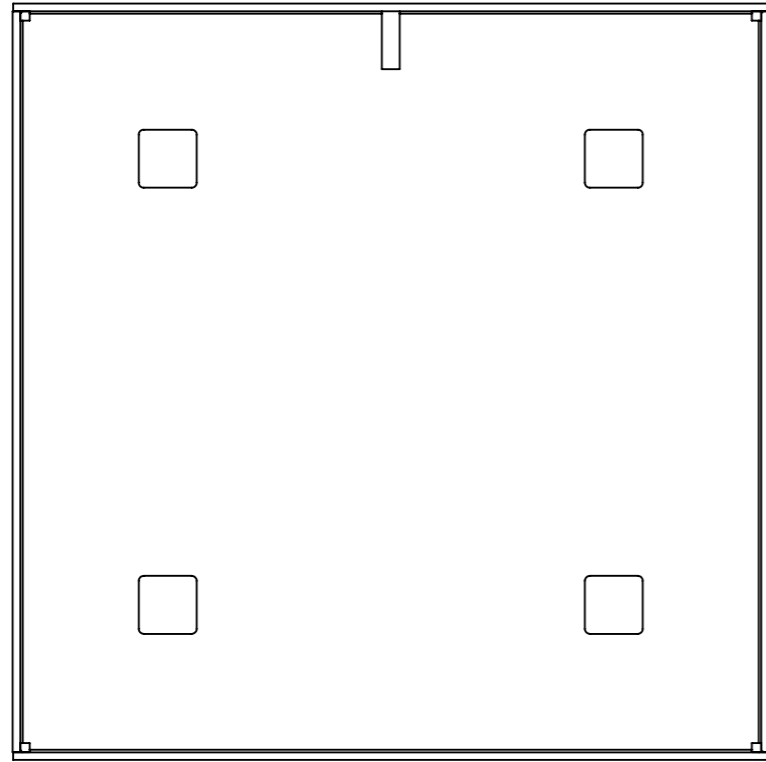

Skimmer Lids Unit 3 / 26 Octal Street, YATALA QLD 4207				DEBUR AND BREAK SHARP EDGES	DO NOT SCALE DRAWING	REVISION
DRAWN	NAME	SIGNATURE	DATE		TITLE:	
	M.P.J.		16/10/2019			
CHK'D						
APPV'D						
MFG						
Q.A				MATERIAL:	DWG NO.	
				3mm Aluminium	306 x 10 kit	A3
				WEIGHT:	SCALE:1:3	SHEET 3 OF 3