

Skimmer Lids 26 Link Drive YATALA QLD 4207				DO NOT SCALE DRAWING		REVISION	
	NAME	SIGNATURE	DATE			TITLE:	
DRAWN	M.P.J.		29/02/2024				
CHK'D							
APPV'D							
MFG							
Q.A				MATERIAL:		DWG NO.	306 x 20 Mk3 kit
				WEIGHT:		SCALE:1:3	A3
						SHEET 1 OF 3	

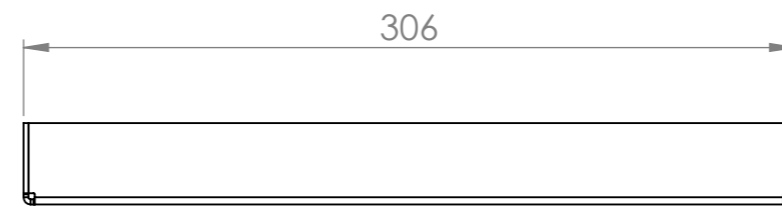

Skimmer Lids 26 Link Drive YATALA QLD 4207				DO NOT SCALE DRAWING		REVISION	
DRAWN	NAME	SIGNATURE	DATE	TITLE:			
	M.P.J.		29/02/2024				
CHK'D							
APPV'D							
MFG							
Q.A				MATERIAL:	DWG NO.		A3
					306 x 20 Mk3 kit		
				WEIGHT:	SCALE:1:3	SHEET 2 OF 3	

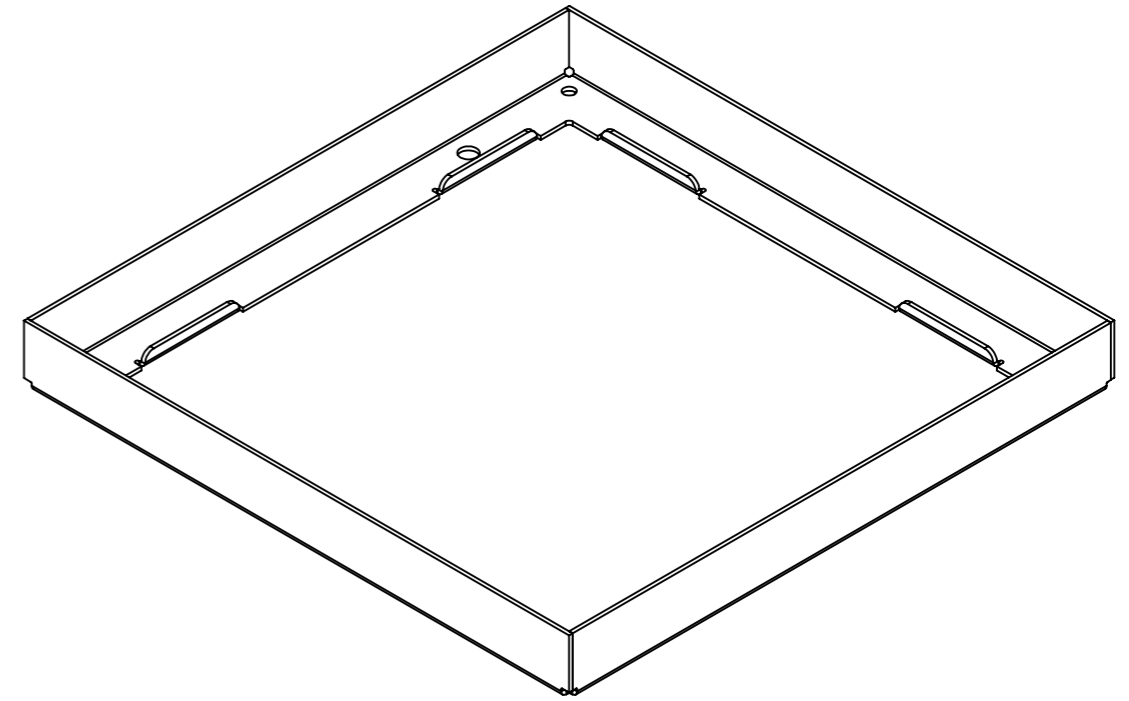
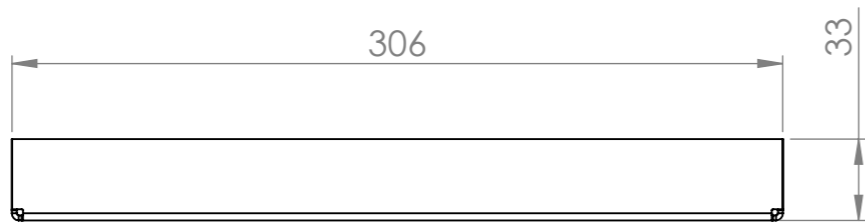
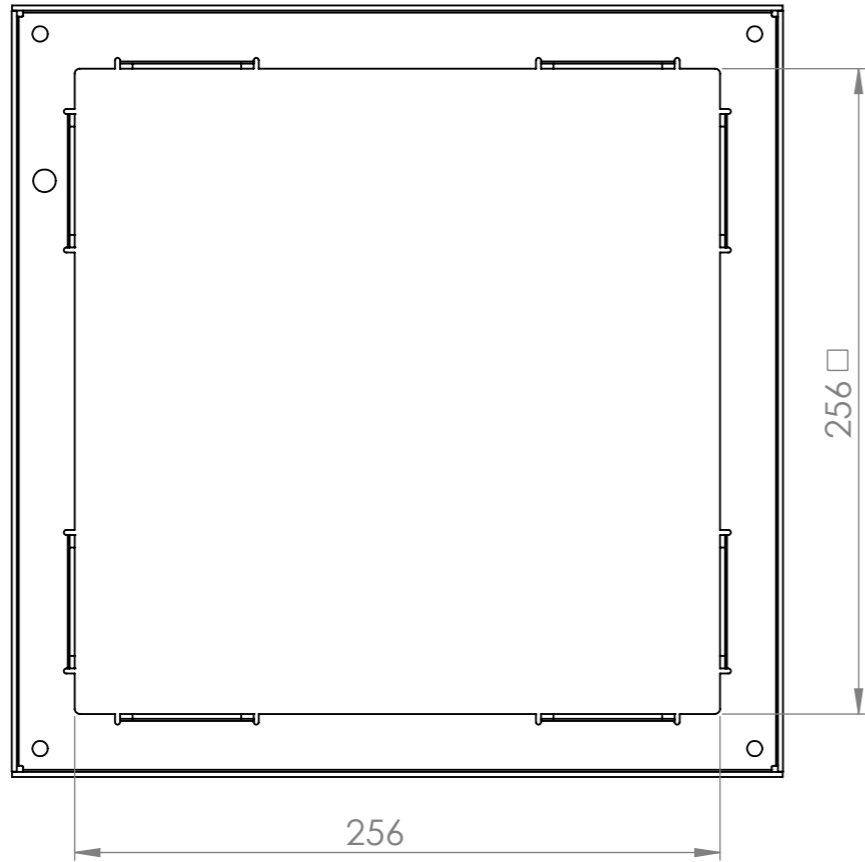
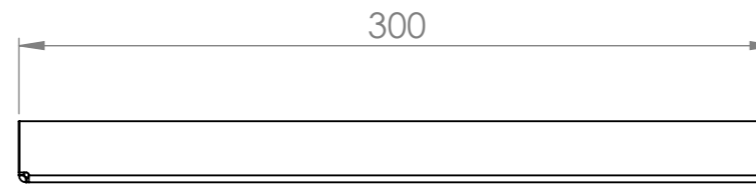
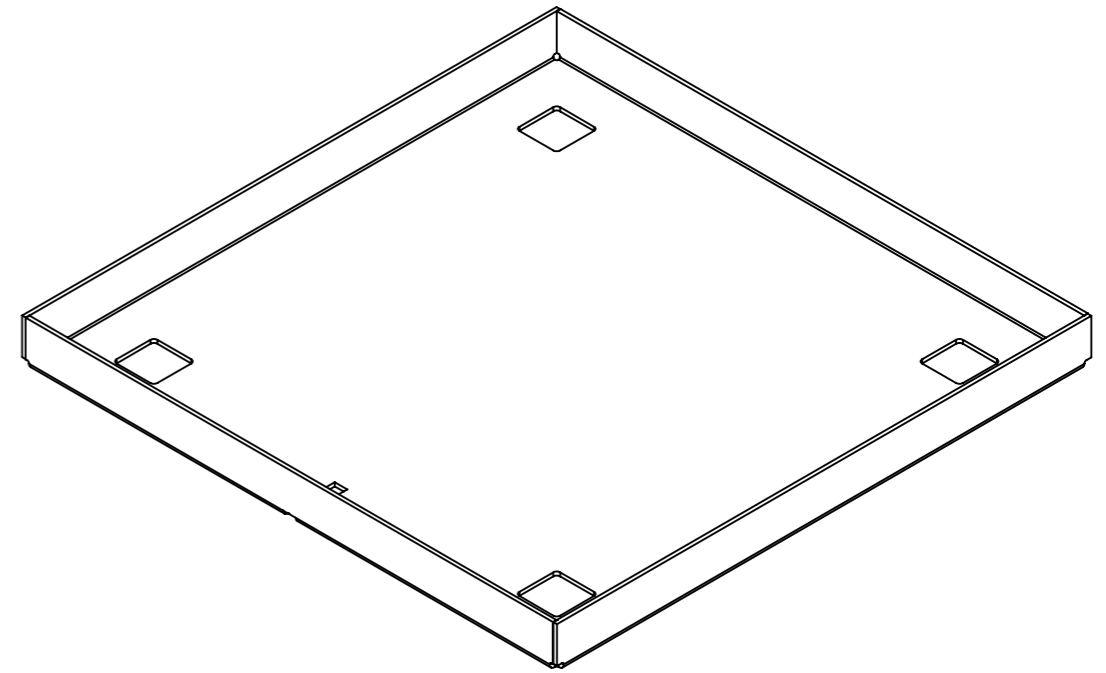
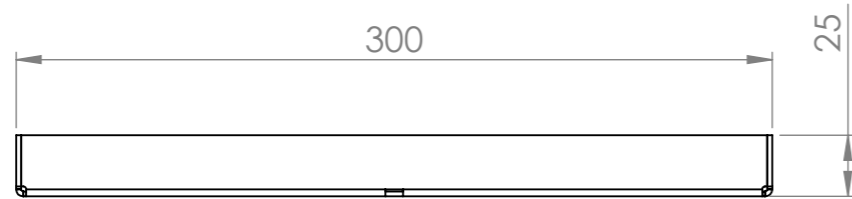
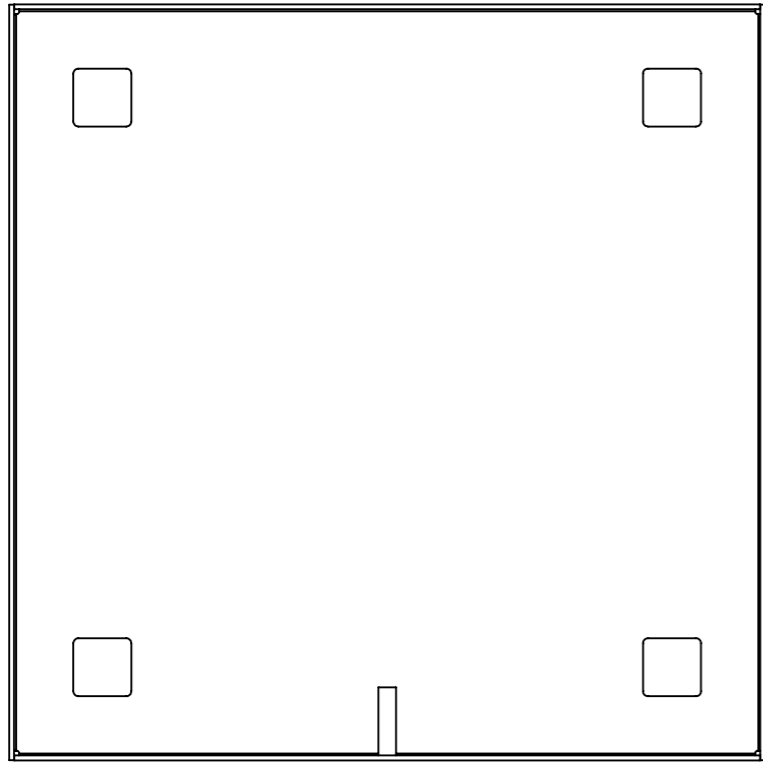

Skimmer Lids 26 Link Drive YATALA QLD 4207				DO NOT SCALE DRAWING		REVISION	
	NAME	SIGNATURE	DATE		TITLE:		
DRAWN	M.P.J.		29/02/2024				
CHK'D							
APPV'D							
MFG							
Q.A				MATERIAL:	DWG NO. 306 x 20 Mk3 kit		A3
				WEIGHT:	SCALE:1:3	SHEET 3 OF 3	