

Skimmer Lids 26 Link Drive YATALA QLD 4207				DO NOT SCALE DRAWING		REVISION	A
				TITLE:			
DRAWN	NAME	SIGNATURE	DATE				
	M.P.J.		13/02/2024				
CHK'D							
APPV'D							
MFG							
Q.A				MATERIAL:		DWG NO.	306 x 30 Mk3 kit
							A3
				WEIGHT:		SCALE:1:3	SHEET 1 OF 3

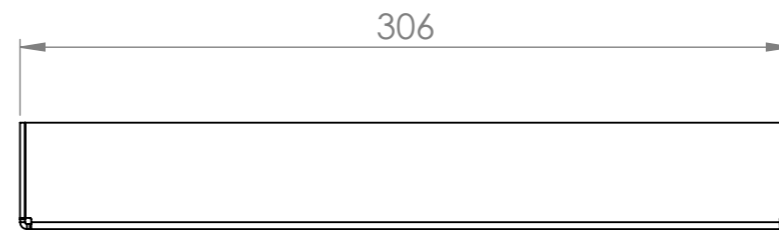

Skimmer Lids 26 Link Drive YATALA QLD 4207				DO NOT SCALE DRAWING		REVISION	A
				TITLE:			
DRAWN	M.P.J.	SIGNATURE	DATE	13/02/2024			
CHK'D							
APPV'D							
MFG							
Q.A					MATERIAL:		
				WEIGHT:		DWG NO.	306 x 30 Mk3 kit
						SCALE:1:3	A3
						SHEET 2 OF 3	

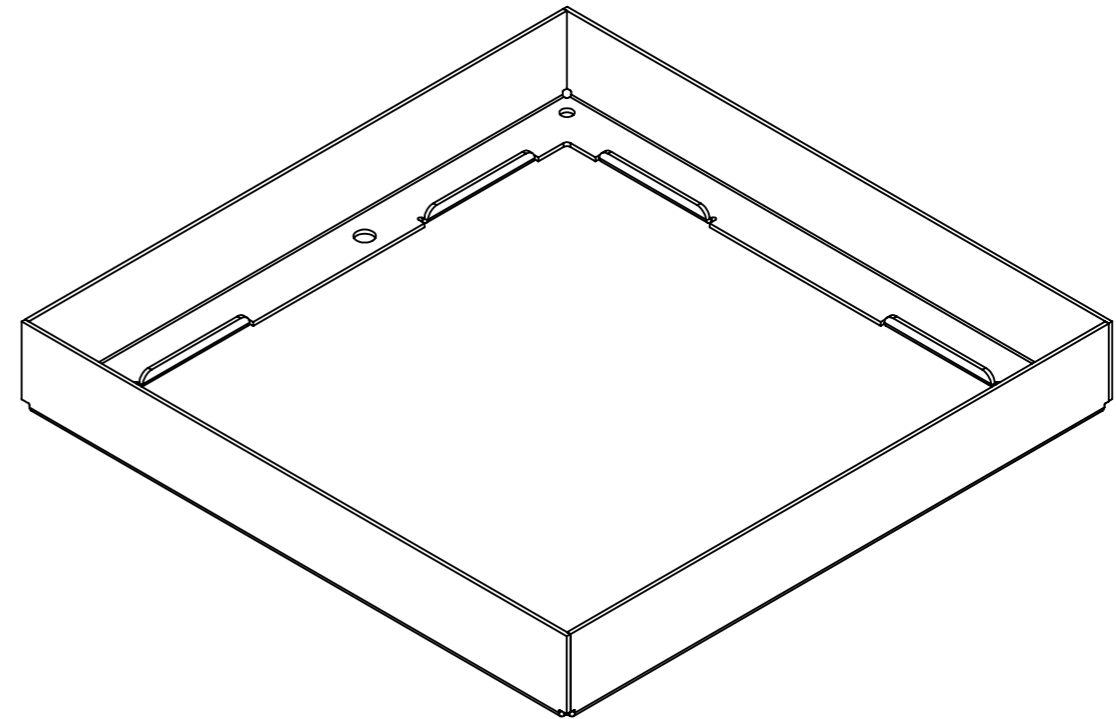
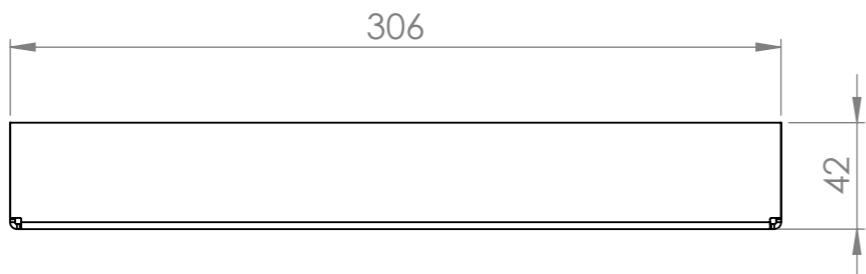
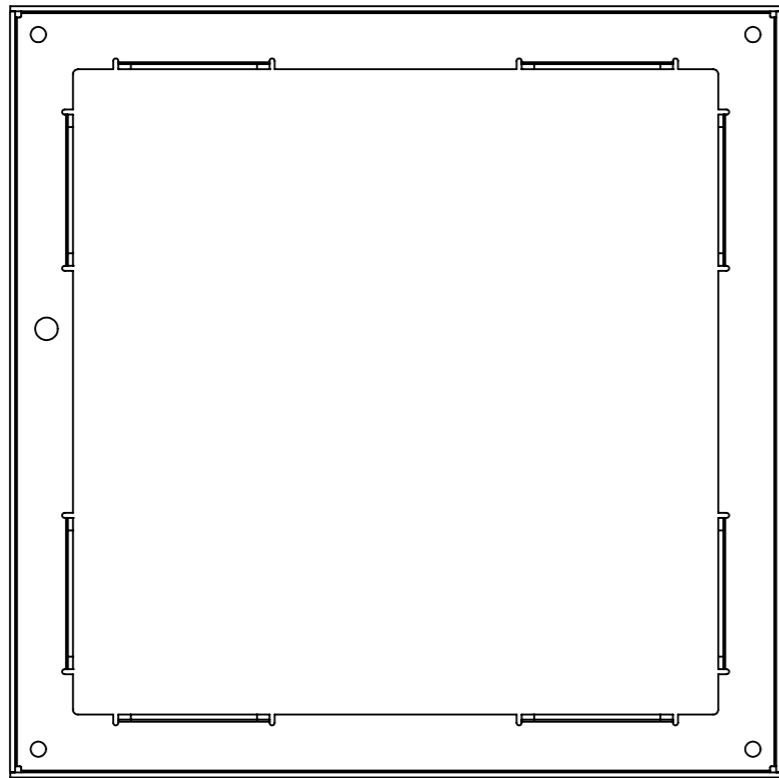
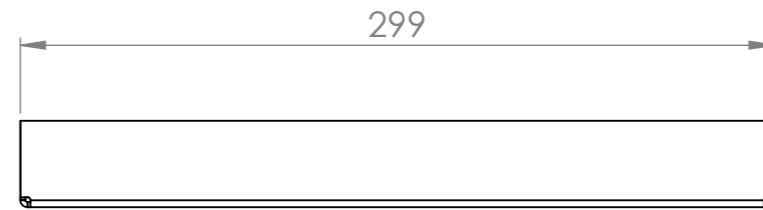
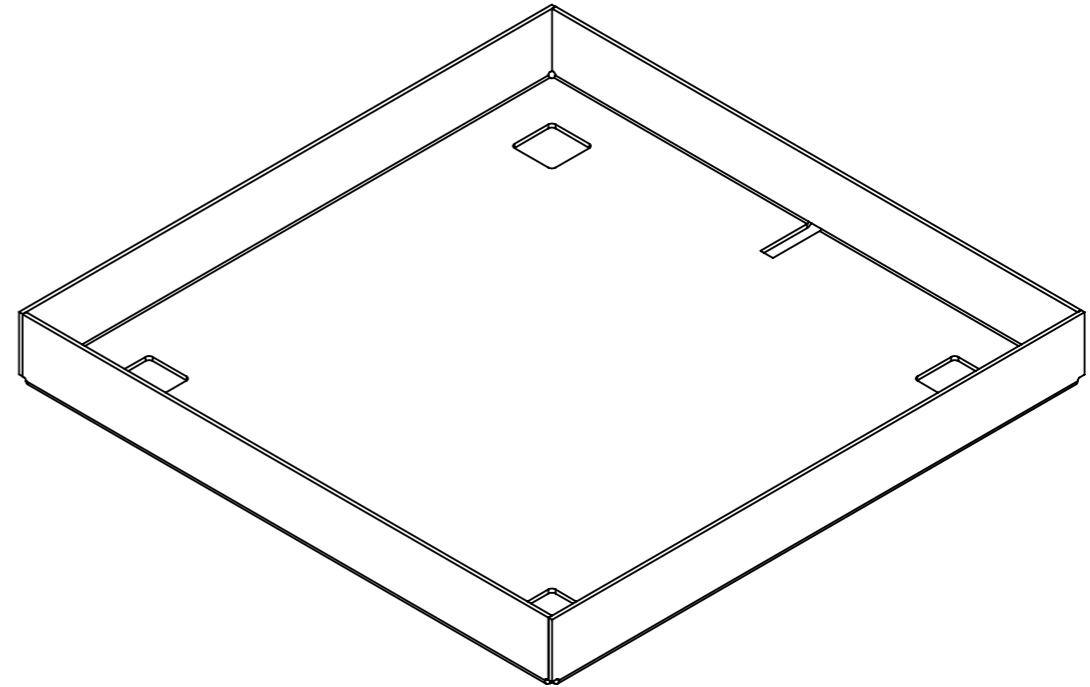
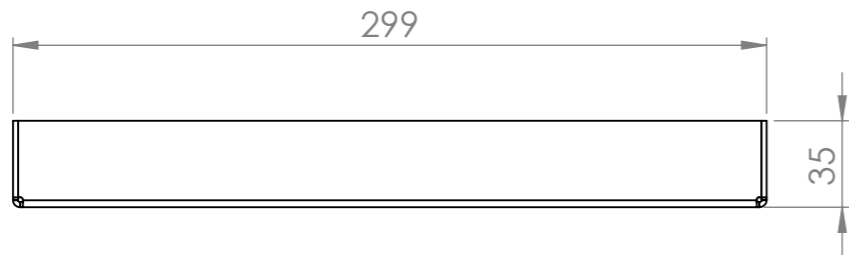
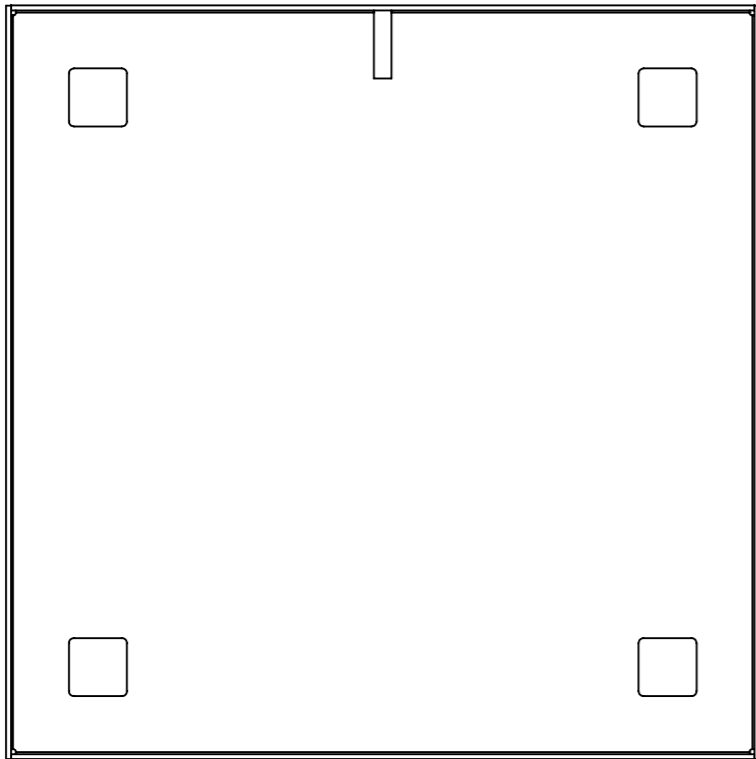

Skimmer Lids 26 Link Drive YATALA QLD 4207				DO NOT SCALE DRAWING		REVISION	A
	NAME	SIGNATURE	DATE			TITLE:	
DRAWN	M.P.J.		13/02/2024				
CHK'D							
APPV'D							
MFG							
Q.A				MATERIAL:		DWG NO.	306 x 30 Mk3 kit
							A3
				WEIGHT:		SCALE:1:3	SHEET 3 OF 3