

| Skimmer Lids<br>26 Link Drive<br>YATALA QLD 4207 |        |           |            | DO NOT SCALE DRAWING |  | REVISION     |                  |
|--|--------|-----------|------------|----------------------|--|--------------|------------------|
|  | NAME   | SIGNATURE | DATE       |                      |  | TITLE:       |                  |
| DRAWN  | M.P.J. |           | 29/02/2024 |                      |  |              |                  |
| CHK'D  |        |           |            |                      |  |              |                  |
| APPV'D   |        |           |            |                      |  |              |                  |
| MFG  |        |           |            |                      |  |              |                  |
| Q.A  |        |           |            | MATERIAL:            |  | DWG NO.      | 306 x 50 Mk3 kit |
|  |        |           |            | WEIGHT:              |  | SCALE:1:3    | A3               |
|  |        |           |            |                      |  | SHEET 1 OF 3 |                  |

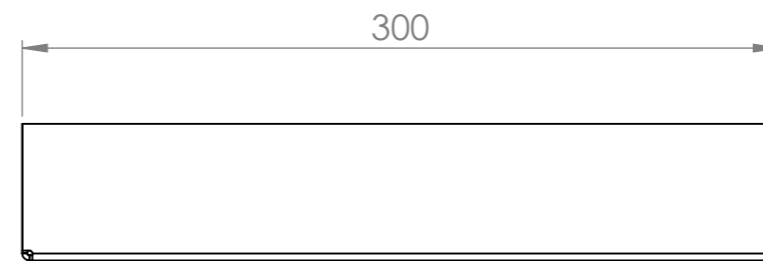

| Skimmer Lids<br>26 Link Drive<br>YATALA QLD 4207 |        |           |            | DO NOT SCALE DRAWING |  | REVISION  |                  |
|--|--------|-----------|------------|----------------------|--|-----------|------------------|
| DRAWN  | NAME   | SIGNATURE | DATE       |                      |  | TITLE:    |                  |
|  | M.P.J. |           | 29/02/2024 |                      |  |           |                  |
| CHK'D  |        |           |            |                      |  |           |                  |
| APPV'D   |        |           |            |                      |  |           |                  |
| MFG  |        |           |            |                      |  |           |                  |
| Q.A  |        |           |            | MATERIAL:            |  | DWG NO.   | 306 x 50 Mk3 kit |
|  |        |           |            |                      |  |           | A3               |
|  |        |           |            | WEIGHT:              |  | SCALE:1:3 | SHEET 2 OF 3     |

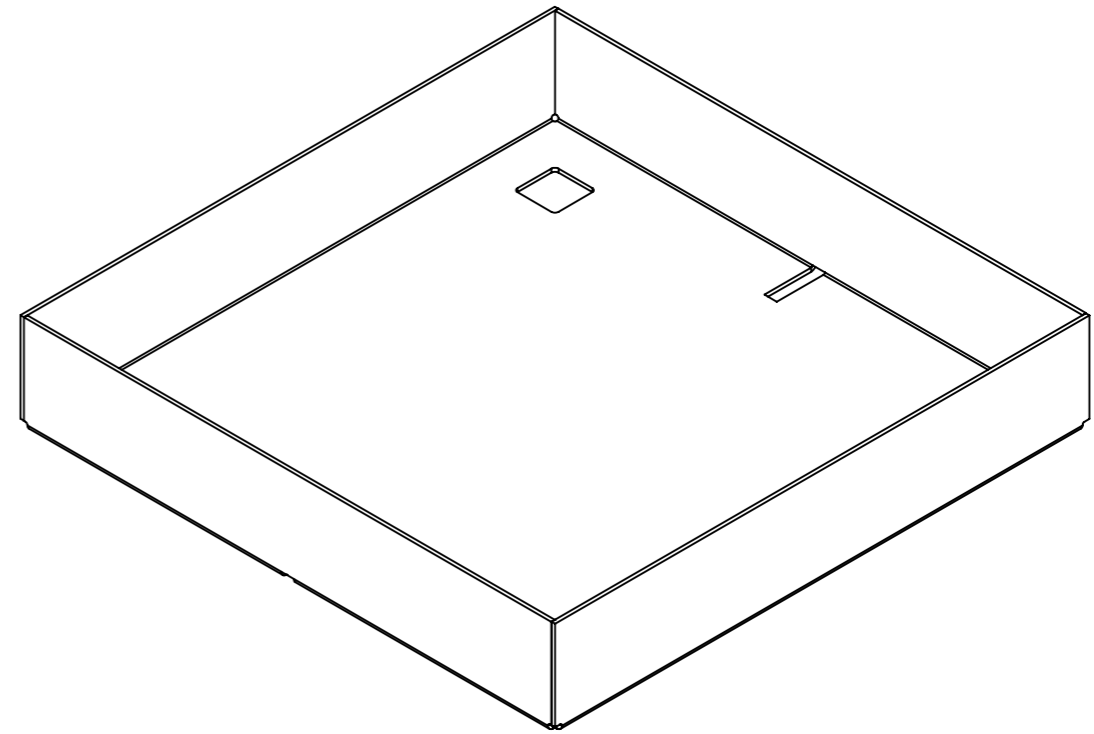
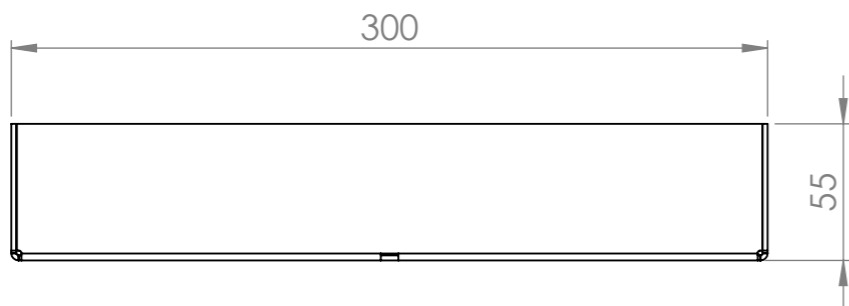
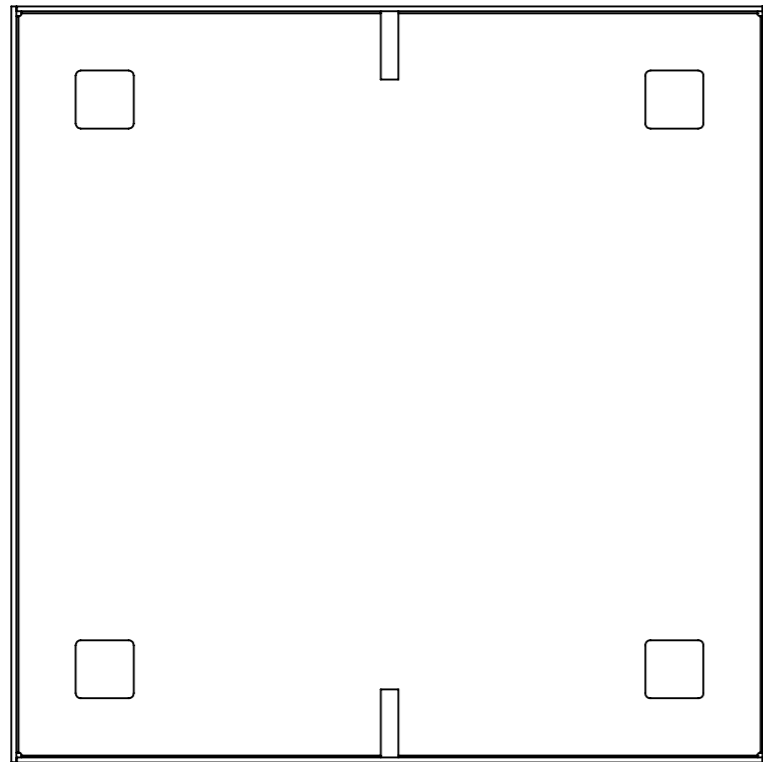
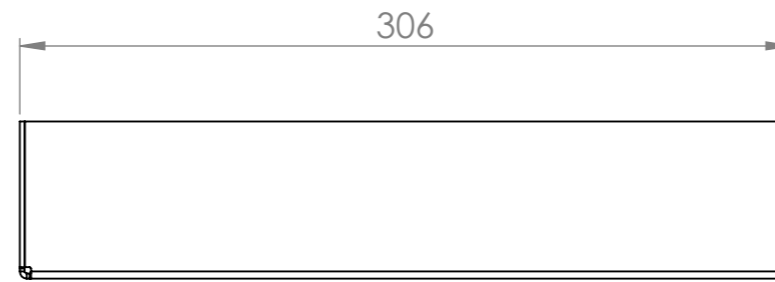
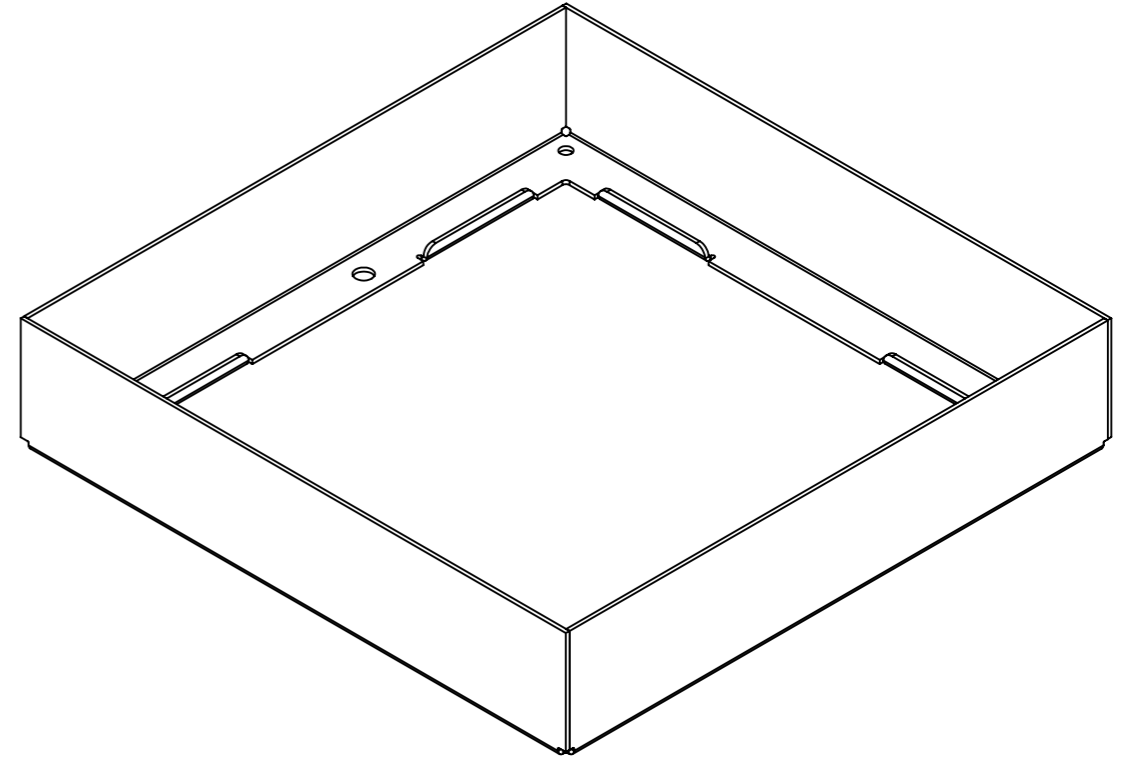
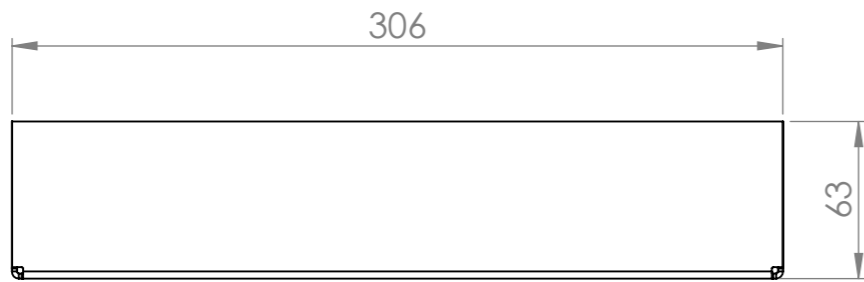
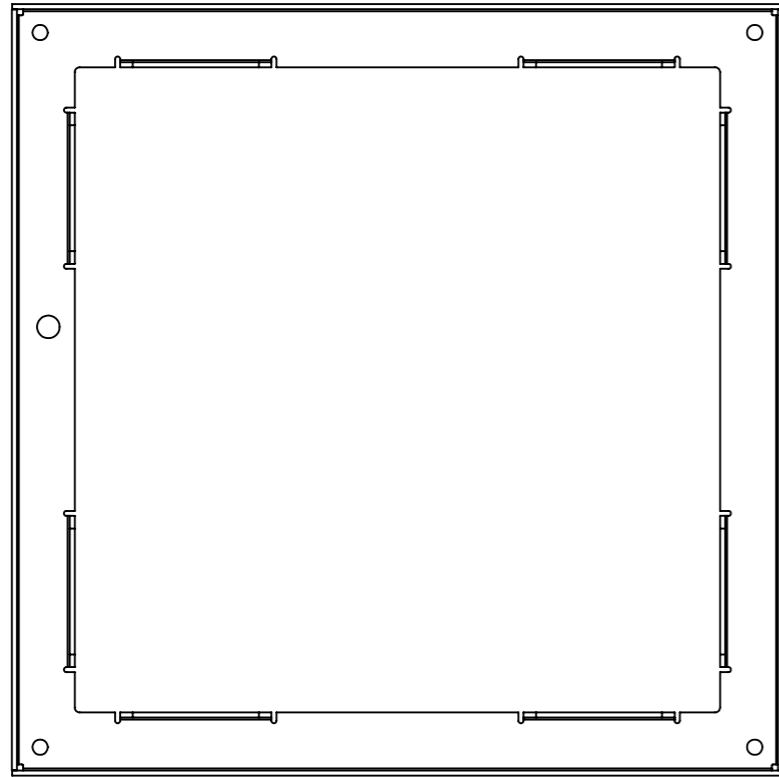

| Skimmer Lids<br>26 Link Drive<br>YATALA QLD 4207 |        |           |            | DO NOT SCALE DRAWING |                  | REVISION     |    |
|--|--------|-----------|------------|----------------------|------------------|--------------|----|
| DRAWN  | NAME   | SIGNATURE | DATE       | TITLE:               |                  |              |    |
|  | M.P.J. |           | 29/02/2024 |                      |                  |              |    |
| CHK'D  |        |           |            |                      |                  |              |    |
| APPV'D   |        |           |            |                      |                  |              |    |
| MFG  |        |           |            |                      |                  |              |    |
| Q.A  |        |           |            | MATERIAL:            | DWG NO.          |              | A3 |
|  |        |           |            |                      | 306 x 50 Mk3 kit |              |    |
|  |        |           |            | WEIGHT:              | SCALE:1:3        | SHEET 3 OF 3 |    |