

Skimmer Lids 26 Link Drive YATALA QLD 4207				DO NOT SCALE DRAWING		REVISION	A
	NAME	SIGNATURE	DATE			TITLE:	
DRAWN	M.P.J.		8/04/2025				
CHK'D							
APPV'D							
MFG							
Q.A				MATERIAL:		DWG NO.	342 x 10 Mk3 kit
							A3
				WEIGHT:		SCALE:1:3	SHEET 1 OF 3

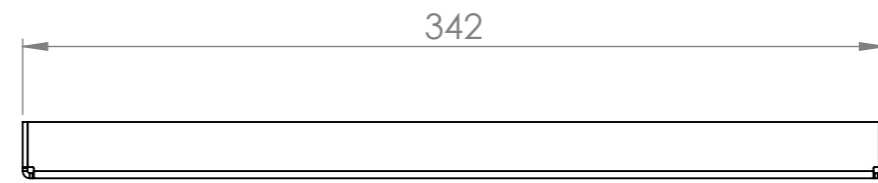

Skimmer Lids 26 Link Drive YATALA QLD 4207				DO NOT SCALE DRAWING		REVISION	A
				TITLE:			
DRAWN	M.P.J.	SIGNATURE	8/04/2025	DATE	DWG NO. <b>342 x 10 Mk3 kit</b>		
CHK'D					A3		
APPV'D					SCALE:1:3		
MFG				MATERIAL:	SHEET 2 OF 3		
Q.A				WEIGHT:			

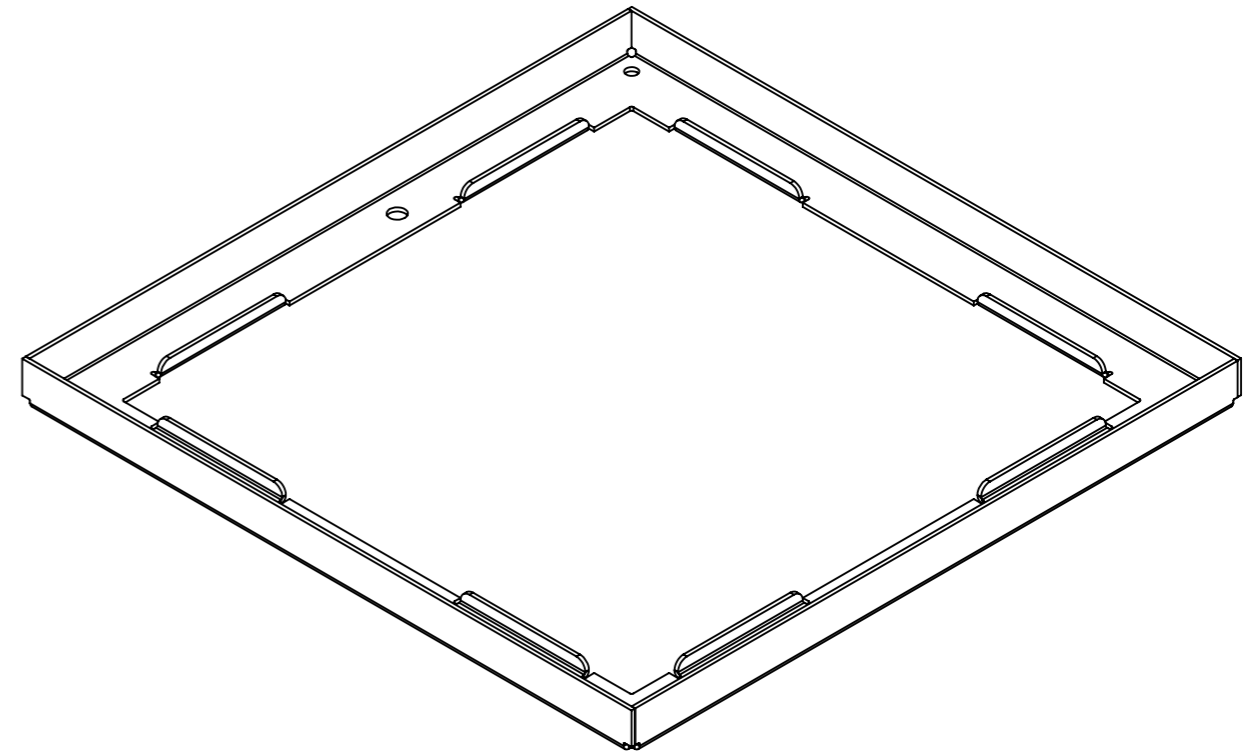
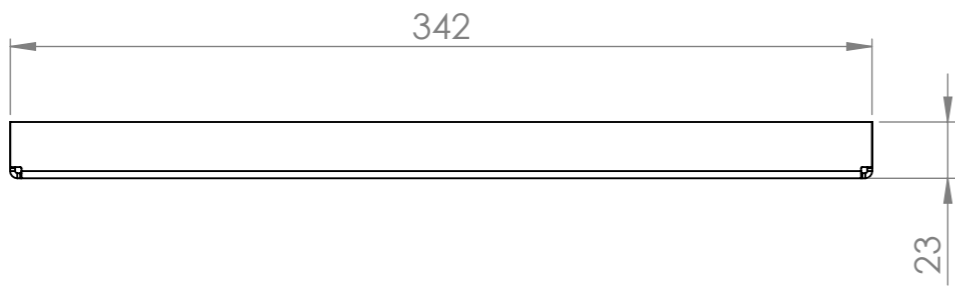
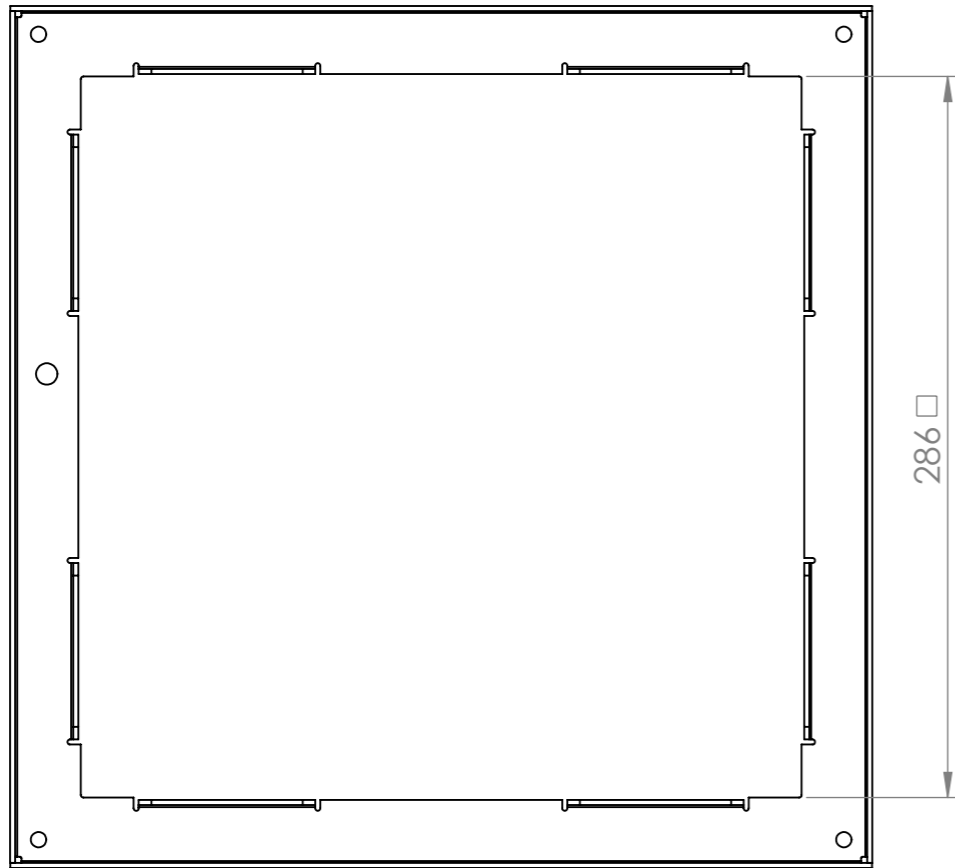
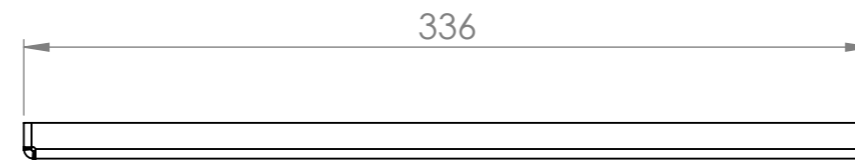
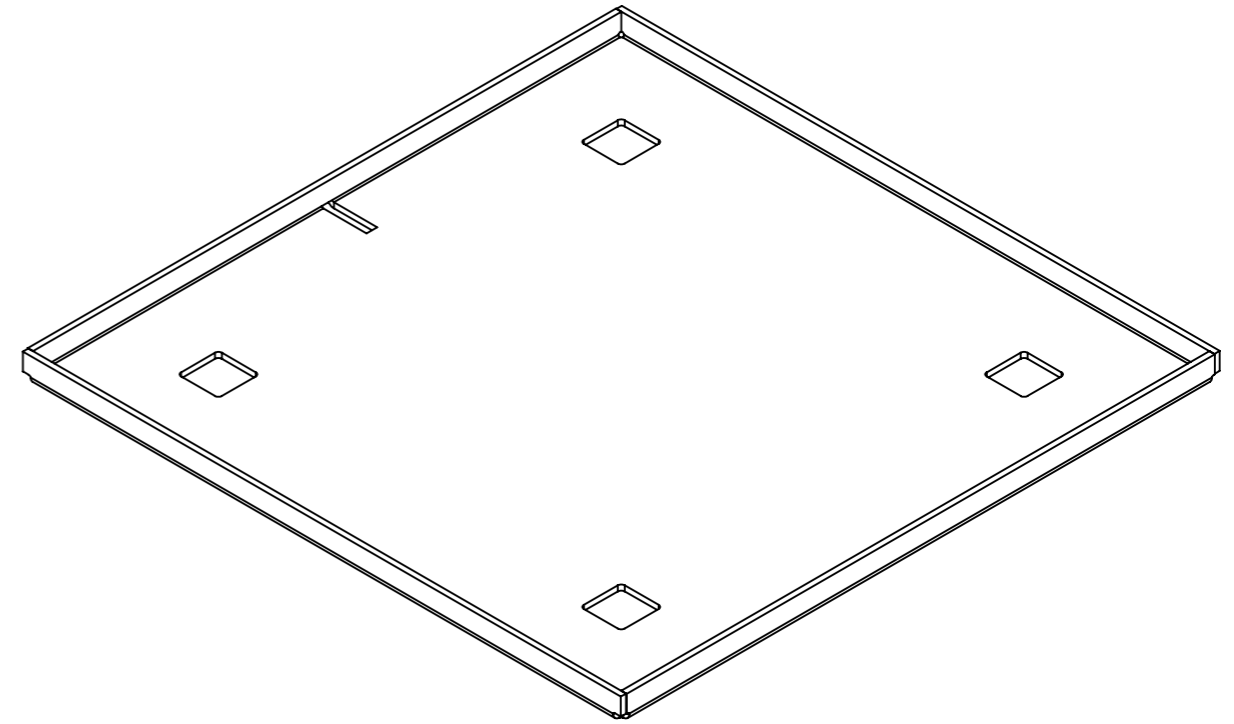
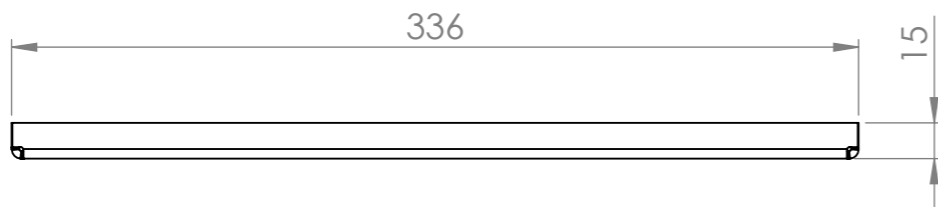
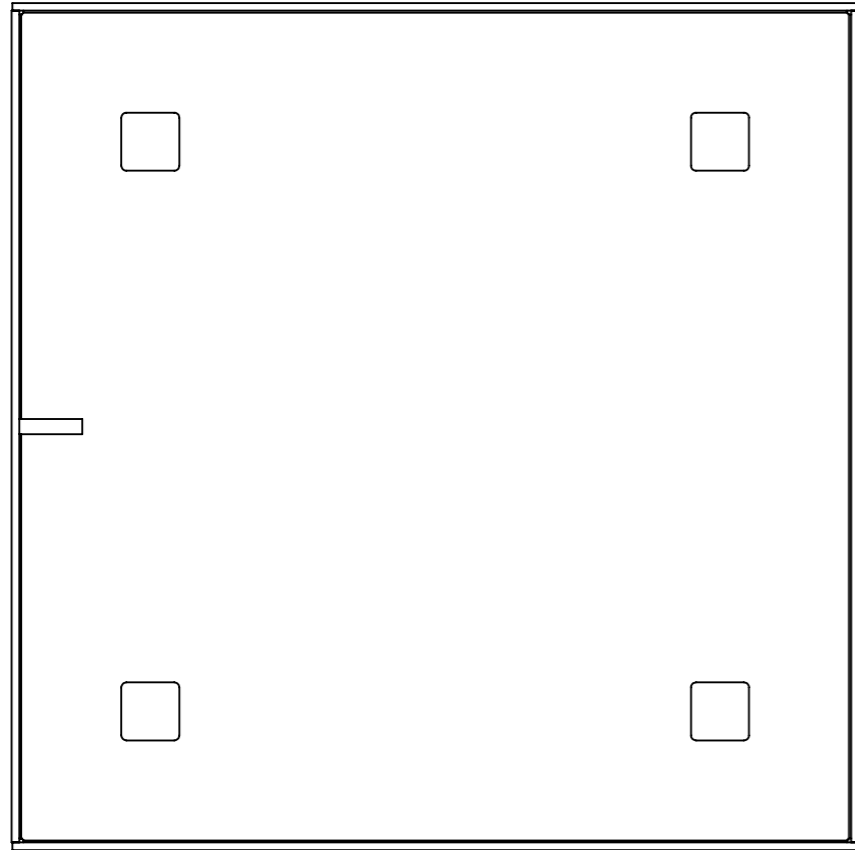

Skimmer Lids 26 Link Drive YATALA QLD 4207				DO NOT SCALE DRAWING		REVISION	A
				TITLE:			
DRAWN	M.P.J.	SIGNATURE	8/04/2025	DATE	DWG NO. <b>342 x 10 Mk3 kit</b>		
CHK'D					A3		
APPV'D					SCALE: 1:3		
MFG					SHEET 3 OF 3		
Q.A				MATERIAL:			
				WEIGHT:			