

Skimmer Lids 26 Link Drive YATALA QLD 4207				DO NOT SCALE DRAWING		REVISION	A
				TITLE:			
DRAWN	NAME	SIGNATURE	DATE				
	M.P.J.		8/04/2025				
CHK'D							
APPV'D							
MFG							
Q.A				MATERIAL:		DWG NO.	342 x 40 Mk3 kit
						SCALE:1:3	A3
				WEIGHT:		SHEET 1 OF 3	

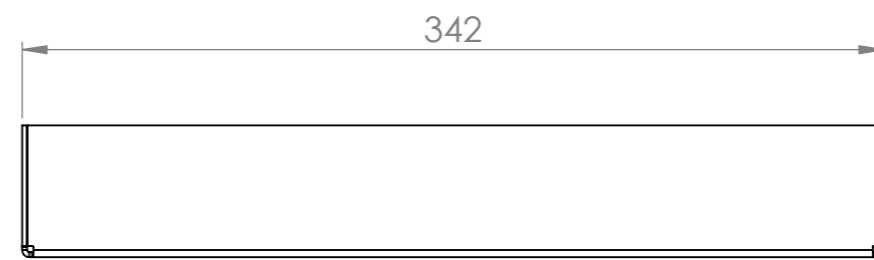

Skimmer Lids 26 Link Drive YATALA QLD 4207				DO NOT SCALE DRAWING		REVISION		A	
DRAWN	NAME	SIGNATURE	DATE			TITLE:			
	M.P.J.		8/04/2025						
CHK'D									
APPV'D									
MFG									
Q.A					MATERIAL:	DWG NO.		342 x 40 Mk3 kit	
						SCALE:1:3		A3	
					WEIGHT:	SHEET 2 OF 3			

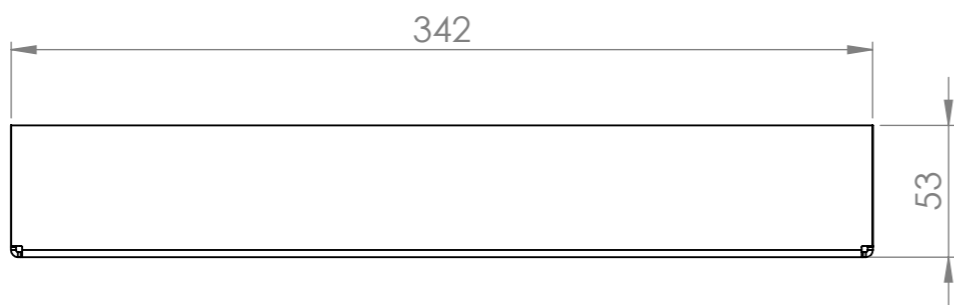
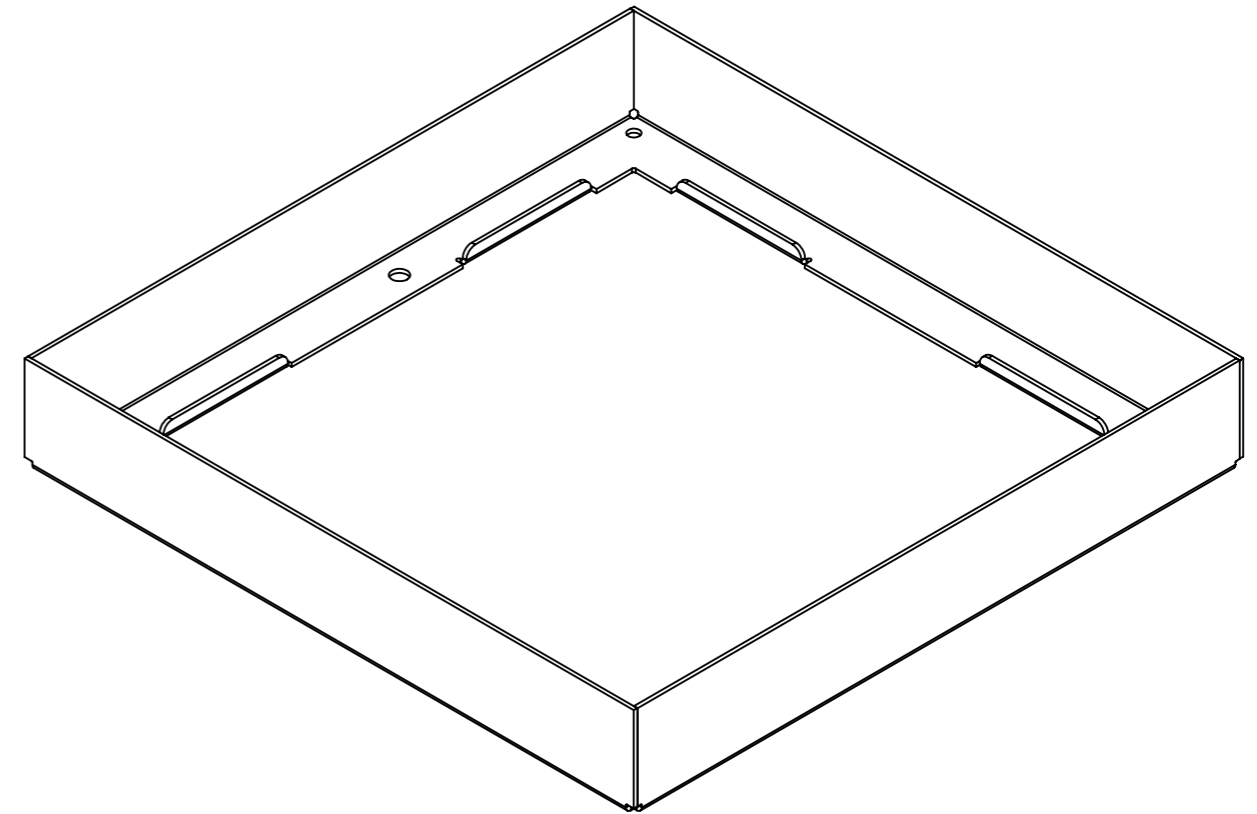
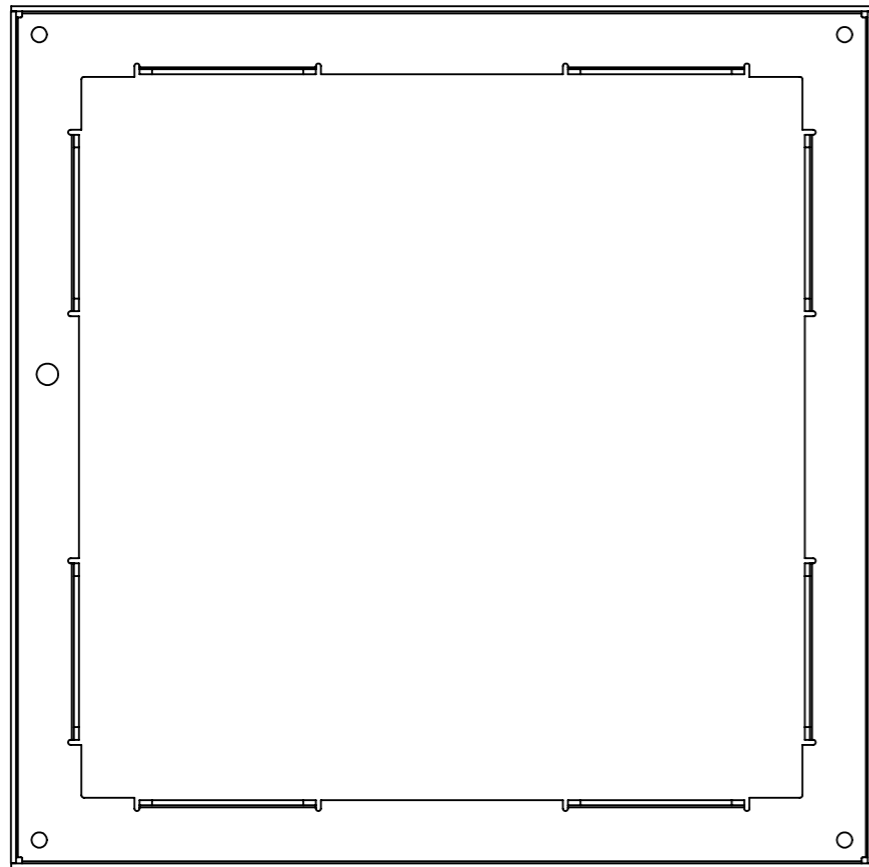
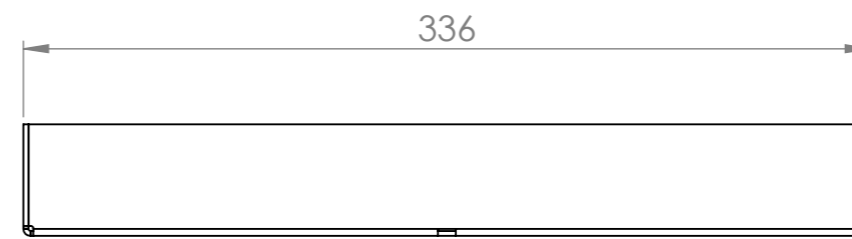
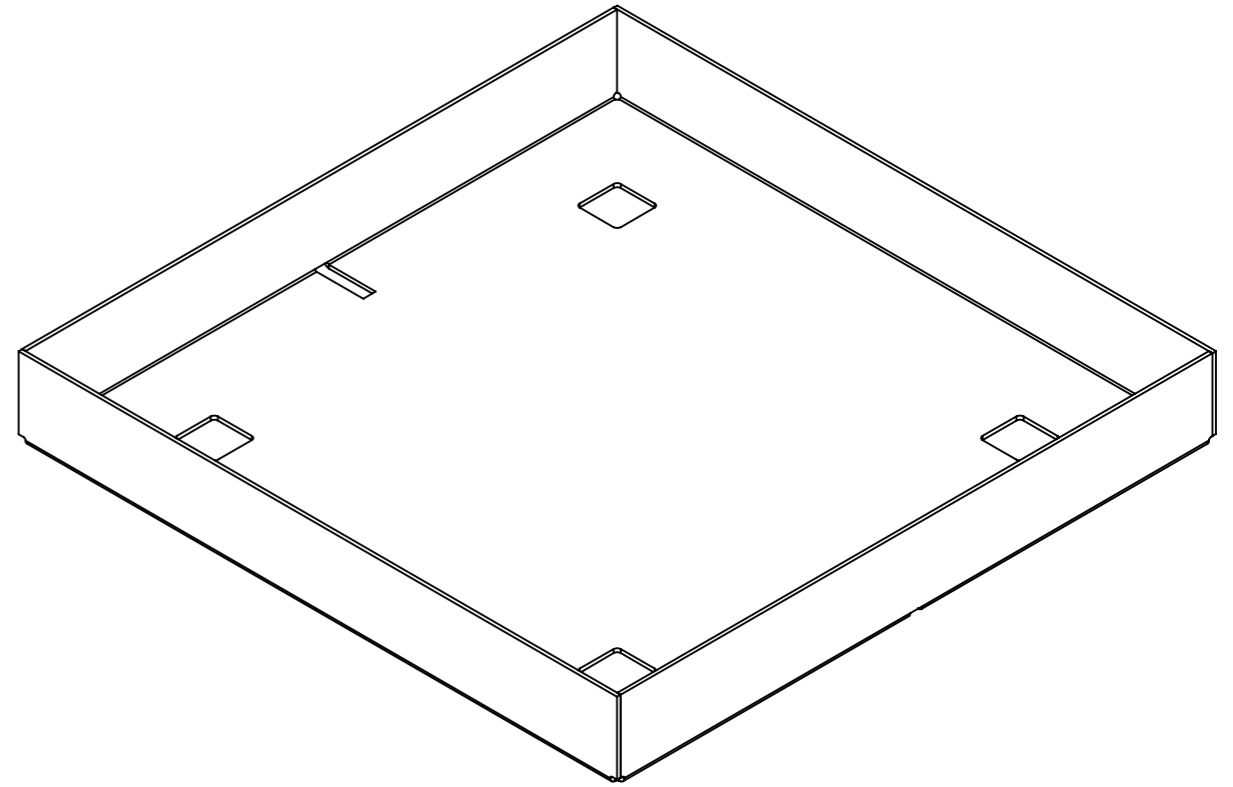
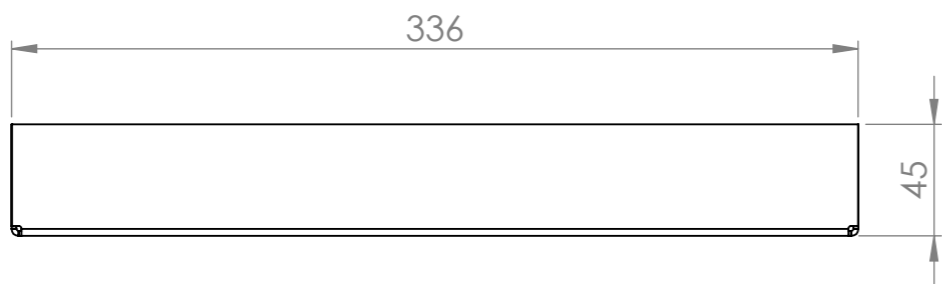
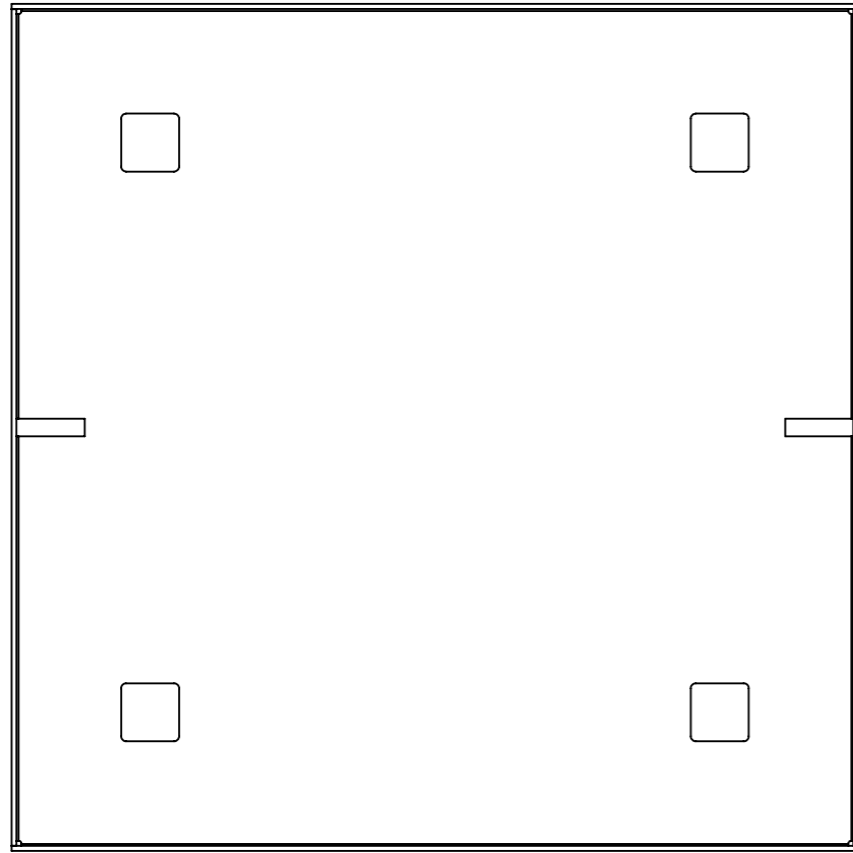

Skimmer Lids 26 Link Drive YATALA QLD 4207				DO NOT SCALE DRAWING		REVISION	A
	NAME	SIGNATURE	DATE			TITLE:	
DRAWN	M.P.J.		8/04/2025				
CHK'D							
APPV'D							
MFG							
Q.A				MATERIAL:		DWG NO.	342 x 40 Mk3 kit
							A3
				WEIGHT:		SCALE:1:3	SHEET 3 OF 3